

Exotic Branes and Superconformal Field Theories

Tetsuji KIMURA
Tokyo Institute of Technology

Contents

1. Exotic branes from F-theory
2. Exotic $SL(2, \mathbb{Z})$ monodromy
3. Applications
 - a. 6D $\mathcal{N} = (2, 0)$
 - b. G-theory
4. Summary and discussions

1 . Exotic branes from F-theory

Consider charged particles in **3D** maximal supergravity :

They are **D7-brane wrapped on 7-torus** and its dualized objects

$$M_{D7} = \frac{R_1 R_2 \cdots R_7}{g_s \ell_s^8}$$

The diagram shows a 7-torus (T₇) and a string (S) with arrows pointing towards the equation. The T₇ arrow points upwards and to the right, while the S arrow points downwards and to the right.

$$T_y : \quad R_y \rightarrow \frac{\ell_s^2}{R_y}, \quad g_s \rightarrow \frac{\ell_s}{R_y} g_s$$

$$S : \quad g_s \rightarrow \frac{1}{g_s}, \quad \ell_s^2 \rightarrow g_s \ell_s^2$$

R_y : compact radius of y -direction

g_s : string coupling constant

ℓ_s : string length

Consider charged particles in **3D** maximal supergravity :

They are **D7-brane wrapped on 7-torus** and its dualized objects

$$M_{D7} = \frac{R_1 R_2 \cdots R_7}{g_s \ell_s^8} \begin{array}{l} \nearrow T_7 \\ \searrow S \end{array} \begin{array}{l} \frac{R_1 R_2 \cdots R_6}{g_s \ell_s^7} = M_{D6} \\ \frac{R_1 R_2 \cdots R_7}{g_s^3 \ell_s^8} \leftarrow \text{exotic!} \end{array}$$

$$T_y : \quad R_y \rightarrow \frac{\ell_s^2}{R_y}, \quad g_s \rightarrow \frac{\ell_s}{R_y} g_s$$

$$S : \quad g_s \rightarrow \frac{1}{g_s}, \quad \ell_s^2 \rightarrow g_s \ell_s^2$$

R_y : compact radius of y -direction

g_s : string coupling constant

ℓ_s : string length

Consider charged particles in 3D maximal supergravity :

They are D7-brane wrapped on 7-torus and its dualized objects

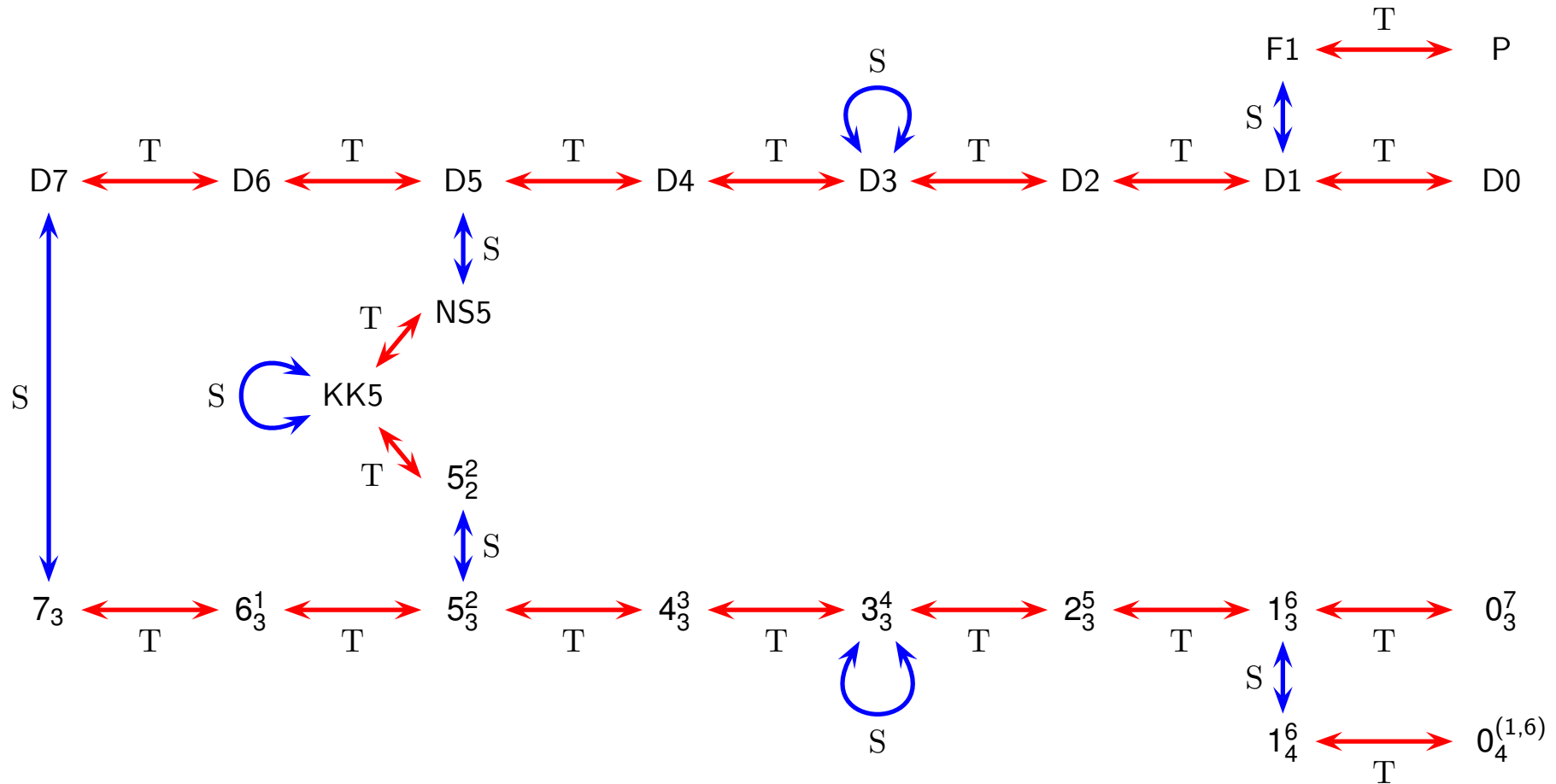

Consider charged particles in **3D** maximal supergravity :

They are **D7-brane wrapped on 7-torus** and its dualized objects

D -dim	IIB				IIA			
3 (240)	D7 (1)	D5 (21)	D3 (35)	D1 (7)	D6 (7)	D4 (35)	D2 (21)	D0 (1)
	F1 (7)	P (7)	NS5 (21)	KK5 (42)	F1 (7)	P (7)	NS5 (21)	KK5 (42)
	1_4^6 (7)	$0_4^{(1,6)}$ (7)	5_2^2 (21)		1_4^6 (7)	$0_4^{(1,6)}$ (7)	5_2^2 (21)	
	7_3 (1)	5_3^2 (21)	3_3^4 (35)	1_3^6 (7)	6_3^1 (7)	4_3^3 (35)	2_3^5 (21)	0_3^7 (1)

$$\begin{aligned}
 \# \text{ of charged particles} &= \# \text{ of } U(1) \text{ gauge one-form potentials} \\
 &= \# \text{ of scalar fields} \\
 &= \dim(E_{8(8)}/SO(16)) = 128 < \mathbf{240} !
 \end{aligned}$$

Consider charged particles in **3D** maximal supergravity :

They are **D7-brane wrapped on 7-torus** and its dualized objects

D -dim	IIB				IIA			
3 (240)	D7 (1)	D5 (21)	D3 (35)	D1 (7)	D6 (7)	D4 (35)	D2 (21)	D0 (1)
	F1 (7)	P (7)	NS5 (21)	KK5 (42)	F1 (7)	P (7)	NS5 (21)	KK5 (42)
	1_4^6 (7)	$0_4^{(1,6)}$ (7)	5_2^2 (21)		1_4^6 (7)	$0_4^{(1,6)}$ (7)	5_2^2 (21)	
	7_3 (1)	5_3^2 (21)	3_3^4 (35)	1_3^6 (7)	6_3^1 (7)	4_3^3 (35)	2_3^5 (21)	0_3^7 (1)

$$b_n^c \text{ has mass (tension)} = \frac{R_1 R_2 \cdots R_b (R_{b+1} \cdots R_{b+c})^2}{g_s^n \ell_s^{b+2c+1}}$$

Consider charged particles in **3D** maximal supergravity :

They are **D7-brane wrapped on 7-torus** and its dualized objects

D -dim	IIB				IIA			
3 (240)	D7 (1)	D5 (21)	D3 (35)	D1 (7)	D6 (7)	D4 (35)	D2 (21)	D0 (1)
	F1 (7)	P (7)	NS5 (21)	KK5 (42)	F1 (7)	P (7)	NS5 (21)	KK5 (42)
	1_4^6 (7)	$0_4^{(1,6)}$ (7)	5_2^2 (21)		1_4^6 (7)	$0_4^{(1,6)}$ (7)	5_2^2 (21)	
	7_3 (1)	5_3^2 (21)	3_3^4 (35)	1_3^6 (7)	6_3^1 (7)	4_3^3 (35)	2_3^5 (21)	0_3^7 (1)

eg.) 5_2^2 -particle in **3D** is uplifted to 5_2^2 -brane in 8D(=5+3) (as codim-2 object).

When exotic 5_2^2 -brane in 8D is embedded into 10D,
 this does not depend on $2 = 10 - 8$ transverse directions. (smearred / KK-reduced)

necessary to keep aspects of codim-2 object

D	U-duality	#	IIB	IIA
10A	1	–	–	–
10B	$SL(2, \mathbb{Z})$	$2 \subset 3$	$D7^{(1)} 7_3^{(1)}$	–
9	$SL(2, \mathbb{Z}) \times \mathbb{Z}_2$	$2 \subset 3$	$D7^{(1)} 7_3^{(1)}$	$D6^{(1)} 6_3^1{}^{(1)}$
8	$SL(3, \mathbb{Z})$	$6 \subset (8, 1)$	$D7^{(1)} 7_3^{(1)} D5^{(1)} 5_3^2{}^{(1)} NS5^{(1)} 5_2^2{}^{(1)}$	$D6^{(2)} 6_3^1{}^{(2)} KK5^{(2)}$
	$\times SL(2, \mathbb{Z})$	$2 \subset (1, 3)$	$KK5^{(2)}$	$NS5^{(1)} 5_2^2{}^{(1)}$
7	$SL(5, \mathbb{Z})$	$20 \subset 24$	$D7^{(1)} 7_3^{(1)} D5^{(3)} 5_3^2{}^{(3)} NS5^{(3)} 5_2^2{}^{(3)}$	$D6^{(3)} 6_3^1{}^{(3)} KK5^{(6)} D4^{(1)} 4_3^3{}^{(1)}$
			$KK5^{(6)}$	$NS5^{(3)} 5_2^2{}^{(3)}$
6	$SO(5, 5; \mathbb{Z})$	$40 \subset 45$	$D7^{(1)} 7_3^{(1)} D5^{(6)} 5_3^2{}^{(6)} NS5^{(6)} 5_2^2{}^{(6)} D3^{(1)} 3_3^4{}^{(1)}$	$D6^{(4)} 6_3^1{}^{(4)} KK5^{(12)} D4^{(4)} 4_3^3{}^{(4)}$
			$KK5^{(12)}$	$NS5^{(6)} 5_2^2{}^{(6)}$
5	$E_{6(6)}(\mathbb{Z})$	$72 \subset 78$	$D7^{(1)} 7_3^{(1)} D5^{(10)} 5_3^2{}^{(10)} NS5^{(10)} 5_2^2{}^{(10)} D3^{(5)} 3_3^4{}^{(5)}$	$D6^{(5)} 6_3^1{}^{(5)} KK5^{(20)} D4^{(10)} 4_3^3{}^{(10)} D2^{(1)} 2_3^5{}^{(1)}$
			$KK5^{(20)}$	$NS5^{(10)} 5_2^2{}^{(10)}$
4	$E_{7(7)}(\mathbb{Z})$	$126 \subset 133$	$D7^{(1)} 7_3^{(1)} D5^{(15)} 5_3^2{}^{(15)} NS5^{(15)} 5_2^2{}^{(15)}$	$D6^{(6)} 6_3^1{}^{(6)} KK5^{(30)} D4^{(20)} 4_3^3{}^{(20)}$
			$D3^{(15)} 3_3^4{}^{(15)} D1^{(1)} 1_3^6{}^{(1)} F1^{(1)} 1_4^6{}^{(1)}$	$D2^{(6)} 2_3^5{}^{(6)} F1^{(1)} 1_4^6{}^{(1)}$
3	$E_{8(8)}(\mathbb{Z})$	$240 \subset 248$	$KK5^{(30)}$	$NS5^{(15)} 5_2^2{}^{(15)}$
			$D7^{(1)} 7_3^{(1)} D5^{(21)} 5_3^2{}^{(21)} NS5^{(21)} 5_2^2{}^{(21)}$	$D6^{(7)} 6_3^1{}^{(7)} KK5^{(42)} D4^{(35)} 4_3^3{}^{(35)}$
			$D3^{(35)} 3_3^4{}^{(35)} D1^{(7)} 1_3^6{}^{(7)} F1^{(7)} 1_4^6{}^{(7)} P^{(7)} 0_4^{(1,6)}{}^{(7)}$	$D2^{(21)} 2_3^5{}^{(21)} F1^{(7)} 1_4^6{}^{(7)} D0^{(1)} 0_3^7{}^{(1)} P^{(7)} 0_4^{(1,6)}{}^{(7)}$
			$KK5^{(42)}$	$NS5^{(21)} 5_2^2{}^{(21)}$

For codim-2, all branes are (un)wrapped on torus along suitable directions.

→ Defect branes

Exotic b_n^c -brane :

- charged particle in 3D, codim-2 object in $(b + 3)$ -dim
- pair with standard b -brane of codim-2 in $(b + 3)$ -dim
- c smeared transverse directions from 10D viewpoint
- tension proportional to g_s^{-n}

D7-brane (codim-2 object in 10D) has been studied for 20 years : **F-theory**

Vafa: [hep-th/9602022](https://arxiv.org/abs/hep-th/9602022)

2. **Exotic $SL(2, \mathbb{Z})$ monodromy**

F-string : couple to $B_{(2)}$

D-string : couple to $C_{(2)}$

D7(1234567) : couple to $\tau(z) = C + i e^{-\phi}$ ($z = x^8 + i x^9 = r e^{i\vartheta}$)

solution : $\tau(z) = \frac{\vartheta}{2\pi} + \frac{i}{2\pi} \log \frac{\Lambda}{r}$

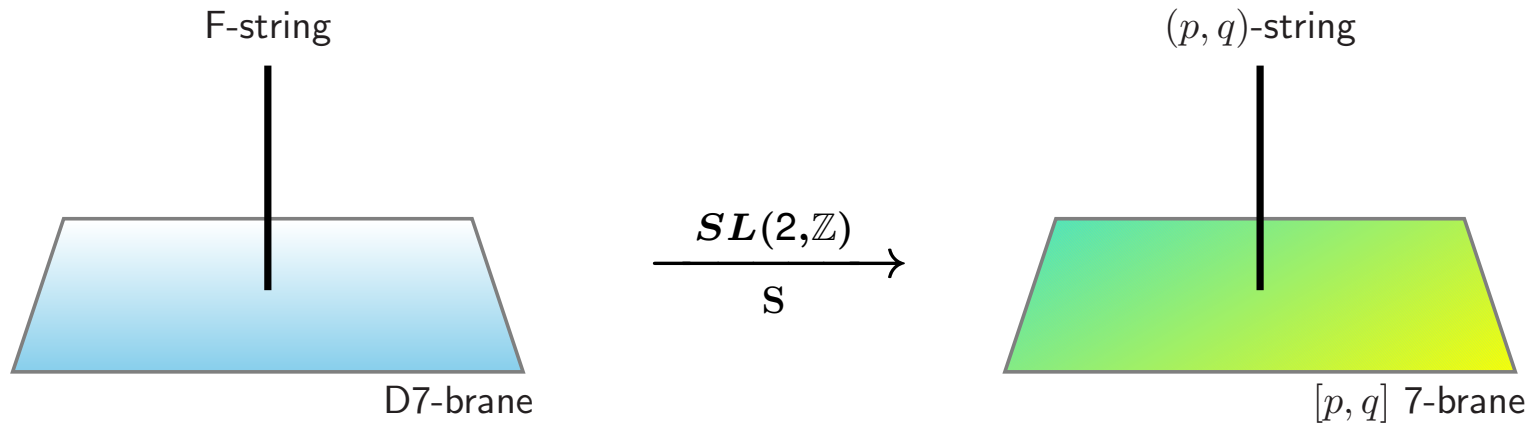

(1, 0)-string = F1

(0, 1)-string = D1

[1, 0] 7-brane = D7(1234567)

[0, 1] 7-brane = $7_3(1234567)$

Open D-string is ending on $7_3(1234567)$.

When τ moves around D7-brane counterclockwise,
it receives a magnetic “charge” of D7-brane (**monodromy**) : $\tau \rightarrow \tau + 1$

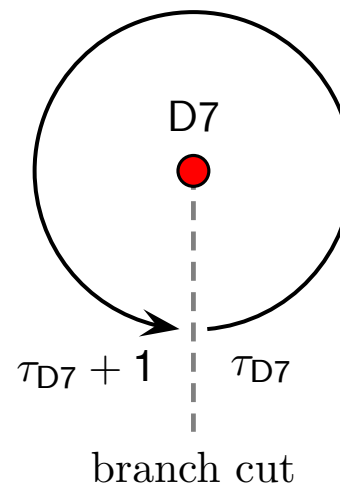

$$\mathbf{K}_{[1,0]} \cdot (\tau + 1) = \tau, \quad \mathbf{K}_{[1,0]} = \begin{pmatrix} 1 & -1 \\ 0 & 1 \end{pmatrix} \in \mathbf{SL}(2, \mathbb{Z})$$

D7-brane : (localized in 89-plane)

$$\tau_{D7}(z) \equiv C + i e^{-\phi} = \frac{\vartheta}{2\pi} + \frac{i}{2\pi} \log \frac{\Lambda}{r} \quad (z = x^8 + i x^9 = r e^{i\vartheta})$$

When τ_{D7} moves around D7-brane counterclockwise $\vartheta \rightarrow \vartheta + 2\pi$,

it receives a magnetic “charge” (**monodromy**) : $\tau_{D7} \rightarrow \tau_{D7} + 1$

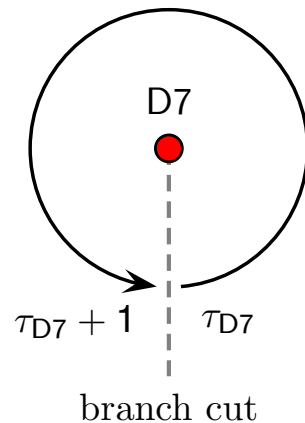

Exotic 5_2^2 -brane : (localized in 89-plane, smeared along 67-directions)

$$\rho_E(z) = B_{67} + i \sqrt{\det G_{mn}} = - \left[\frac{\vartheta}{2\pi} + \frac{i}{2\pi} \log \frac{\Lambda}{r} \right]^{-1} \quad (z = x^8 + ix^9 = r e^{i\vartheta})$$

When ρ_E moves around 5_2^2 -brane counterclockwise $\vartheta \rightarrow \vartheta + 2\pi$,

it receives a magnetic “charge” (**monodromy**) : $-1/\rho_E \rightarrow -1/\rho_E + 1$

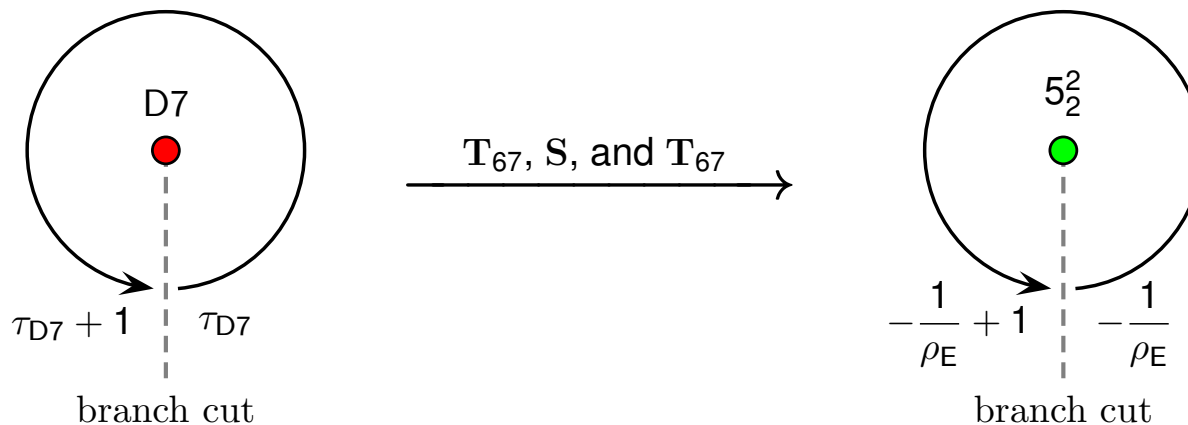

$$D7 \xrightarrow{T_{67}} D5 \xrightarrow{S} NS5 \xrightarrow{T_{67}} 5_2^2$$

Exotic 5_2^2 -brane : (localized in 89-plane, smeared along 67-directions)

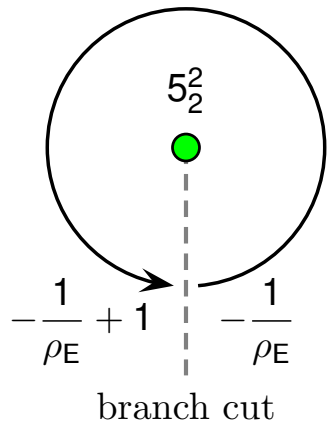

$$SL(2, \mathbb{Z}) : -\frac{1}{\rho_E} \rightarrow -\frac{1}{\rho_E} + 1 \quad \text{where} \quad -\frac{1}{\rho_E} = \rho_{\text{NS5}}$$

We **cannot** remove this shift

by $\left\{ \begin{array}{l} \text{B-field gauge transformation} \\ \text{coordinate transformations} \end{array} \right.$

This property comes from

$$\begin{array}{l} SL(2, \mathbb{Z}) \\ \text{complex structure} \end{array} \times \begin{array}{l} SL(2, \mathbb{Z}) \\ \text{complexified Kähler} \end{array} = \begin{array}{l} SO(2, 2; \mathbb{Z}) \\ \text{T}_{67}\text{-duality} \end{array}$$

Exotic $SL(2, \mathbb{Z})$ pairs by monodromy matrix $K_{[p,q]}$:

D7 in 10-dim $\xrightarrow{K_{[p,q]}}$ $[p, q]_7^S$ -brane D b in $(b + 3)$ -dim $\xrightarrow{K_{[p,q]}}$ $[p, q]_{db}^E$ -brane

NS5 in 8-dim $\xrightarrow{K_{[p,q]}}$ $[p, q]_{s5}^T$ -brane KK5 in 8-dim $\xrightarrow{K_{[p,q]}}$ $[p, q]_{k5}^T$ -brane

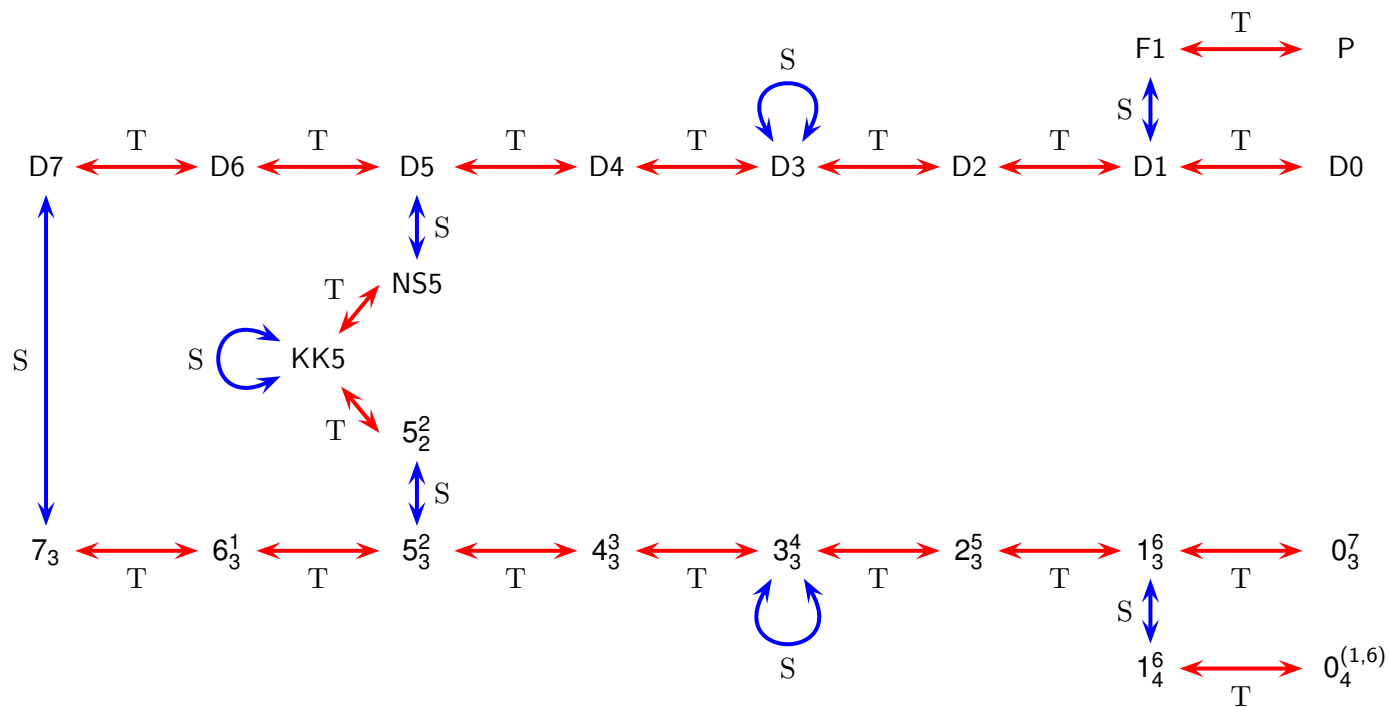

3. Applications

D	U-duality	IIB	IIA
10B	$SL(2, \mathbb{Z})$	D7 7_3	–
9	$SL(2, \mathbb{Z}) \times \mathbb{Z}_2$	D7 7_3	D6 6_3^1
8	$SL(3, \mathbb{Z})$ $\times SL(2, \mathbb{Z})$	D7 7_3 D5 5_3^2 NS5 5_2^2 KK5	D6 6_3^1 KK5 NS5 5_2^2
7	$SL(5, \mathbb{Z})$	D7 7_3 D5 5_3^2 NS5 5_2^2 KK5	D6 6_3^1 KK5 D4 4_3^3 NS5 5_2^2
6	$SO(5, 5; \mathbb{Z})$	D7 7_3 D5 5_3^2 NS5 5_2^2 D3 3_3^4 KK5	D6 6_3^1 KK5 D4 4_3^3 NS5 5_2^2
\vdots	\vdots	\vdots	\vdots

Defect branes (codim-2 branes) in diverse dimensions

D	U-duality	IIB	IIA
10B	$SL(2, \mathbb{Z})$	D7 7_3	–
9	$SL(2, \mathbb{Z}) \times \mathbb{Z}_2$	D7 7_3	D6 6_3^1
8	$SL(3, \mathbb{Z})$ $\times SL(2, \mathbb{Z})$	D7 7_3 D5 5_3^2 NS5 5_2^2 KK5	D6 6_3^1 KK5 NS5 5_2^2
7	$SL(5, \mathbb{Z})$	D7 7_3 D5 5_3^2 NS5 5_2^2 KK5	D6 6_3^1 KK5 D4 4_3^3 NS5 5_2^2
6	$SO(5, 5; \mathbb{Z})$	D7 7_3 D5 5_3^2 NS5 5_2^2 D3 3_3^4 KK5	D6 6_3^1 KK5 D4 4_3^3 NS5 5_2^2
\vdots	\vdots	\vdots	\vdots

F-theory

Greene, Shapere, Vafa, Yau: NPB337 (1990) 1

Vafa: hep-th/9602022

and many works

D	U-duality	IIB	IIA
10B	$SL(2, \mathbb{Z})$	D7 7_3	–
9	$SL(2, \mathbb{Z}) \times \mathbb{Z}_2$	D7 7_3	D6 6_3^1
8	$SL(3, \mathbb{Z})$	D7 7_3 D5 5_3^2 NS5 5_2^2	D6 6_3^1 KK5
	$\times SL(2, \mathbb{Z})$	KK5	NS5 5_2^2
7	$SL(5, \mathbb{Z})$	D7 7_3 D5 5_3^2 NS5 5_2^2	D6 6_3^1 KK5 D4 4_3^3
		KK5	NS5 5_2^2
6	$SO(5, 5; \mathbb{Z})$	D7 7_3 D5 5_3^2 NS5 5_2^2 D3 3_3^4	D6 6_3^1 KK5 D4 4_3^3
		KK5	NS5 5_2^2
\vdots	\vdots	\vdots	\vdots

3D T_3 theory and its mirror dual

D	U-duality	IIB	IIA
10B	$SL(2, \mathbb{Z})$	D7 7_3	–
9	$SL(2, \mathbb{Z}) \times \mathbb{Z}_2$	D7 7_3	D6 6_3^1
8	$SL(3, \mathbb{Z})$	D7 7_3 D5 5_3^2 NS5 5_2^2	D6 6_3^1 KK5
	$\times SL(2, \mathbb{Z})$	KK5	NS5 5_2^2
7	$SL(5, \mathbb{Z})$	D7 7_3 D5 5_3^2 NS5 5_2^2	D6 6_3^1 KK5 D4 4_3^3
		KK5	NS5 5_2^2
6	$SO(5, 5; \mathbb{Z})$	D7 7_3 D5 5_3^2 NS5 5_2^2 D3 3_3^4	D6 6_3^1 KK5 D4 4_3^3
		KK5	NS5 5_2^2
\vdots	\vdots	\vdots	\vdots

Defect (p, q) 5-branes for 6D $\mathcal{N} = (2, 0)$

D	U-duality	IIB	IIA
10B	$SL(2, \mathbb{Z})$	D7 7_3	–
9	$SL(2, \mathbb{Z}) \times \mathbb{Z}_2$	D7 7_3	D6 6_3^1
8	$SL(3, \mathbb{Z})$ $\times SL(2, \mathbb{Z})$	D7 7_3 D5 5_3^2 NS5 5_2^2 KK5	D6 6_3^1 KK5 NS5 5_2^2
7	$SL(5, \mathbb{Z})$	D7 7_3 D5 5_3^2 NS5 5_2^2 KK5	D6 6_3^1 KK5 D4 4_3^3 NS5 5_2^2
6	$SO(5, 5; \mathbb{Z})$	D7 7_3 D5 5_3^2 NS5 5_2^2 D3 3_3^4 KK5	D6 6_3^1 KK5 D4 4_3^3 NS5 5_2^2
\vdots	\vdots	\vdots	\vdots

G-theory

Martucci, Morales, Ricci Pacifici: [arXiv:1207.6120](https://arxiv.org/abs/1207.6120)

Braun, Fucito, Morales: [arXiv:1308.0553](https://arxiv.org/abs/1308.0553)

Candelas, Constantin, Damian, Larfors, Morales: [arXiv:1411.4785](https://arxiv.org/abs/1411.4785), [1411.4786](https://arxiv.org/abs/1411.4786)

Font, García-Etxebarria, Lüst, Massai, Mayrhofer: [arXiv:1603.09361](https://arxiv.org/abs/1603.09361)

Towards 6D $\mathcal{N} = (2, 0)$

via defect (p, q) 5-branes collapsing

Single defect (p, q) 5-brane is a solution in type IIA SUGRA : (non-vanishing p, q case)

$$ds^2 = ds_{012345}^2 + \frac{H}{q^2 K} \left[(dx^6)^2 + (dx^7)^2 \right] + H \left[(dr)^2 + r^2 (d\vartheta)^2 \right]$$

$$B_{67} = -\frac{p}{q} - \frac{V}{q^2 K}, \quad e^{2\phi} = \frac{H}{q^2 K}, \quad \rho = B_{67} + i\sqrt{\det G_{mn}}$$

$$H = \frac{1}{2\pi} \log \frac{\Lambda}{r}, \quad V = \frac{\vartheta}{2\pi}, \quad K = H^2 + V^2$$

TK: arXiv:1410.8403

Special cases $(1, 0)$: defect NS5-brane $([1, 0]_{s5}^T)$, $(0, 1)$: exotic 5_2^2 -brane $([0, 1]_{s5}^T)$

Complex scalar ρ has $SL(2, \mathbb{Z})_\rho \subset SO(2, 2; \mathbb{Z})$ monodromy matrix

$$\begin{pmatrix} 1 + pq & -p^2 \\ q^2 & 1 - pq \end{pmatrix}$$

Completely parallel to the discussion of $[p, q]$ 7-brane, except for the stringy meaning of $SL(2, \mathbb{Z})$

Now, we assign various defect (p, q) 5-branes as follows :

A-brane : $(1, 0)$ 5-brane (= defect NS5)

B-brane : $(1, -1)$ 5-brane

C-brane : $(1, +1)$ 5-brane

We can consider collapsible defect 5-branes by A, B, C-branes as in F-theory

branes	symmetry	fixed point ρ_*
A^7BC^2	E_8	$e^{i\pi/3}$
A^6BC^2	E_7	i
A^5BC^2	E_6	$e^{i\pi/3}$
A^4BC	D_4	$\forall \rho$
AC	H_0	$e^{i\pi/3}$
A^2C	H_1	i
A^3C	H_2	$e^{i\pi/3}$
A^n	A_n	$i\infty$
$A^{n+4}BC$	D_{n+4}	$i\infty$

Since each brane is of NS-type in IIA,
6D $\mathcal{N} = (2, 0)$ theory with symmetry should be realized.

Orientifold 5-plane ($ONS5_A^-$) can be constructed
by collapsing B and C.

$\rho_2 = \sqrt{\det G_{mn}} = e^{+2\phi}$ is **not** small.

G-theory

auxiliary K3 fibration over $\mathbb{C}P^1$ in “14D” theory

(a review)

Martucci, Morales, Ricci Pacifici: [arXiv:1207.6120](https://arxiv.org/abs/1207.6120)

Braun, Fucito, Morales: [arXiv:1308.0553](https://arxiv.org/abs/1308.0553)

 Candelas, Constantin, Damian, Larfors, Morales: [arXiv:1411.4785](https://arxiv.org/abs/1411.4785), [1411.4786](https://arxiv.org/abs/1411.4786)

Font, García-Etxebarria, Lüst, Massai, Mayrhofer: [arXiv:1603.09361](https://arxiv.org/abs/1603.09361)

Begin with a warped CY 3-fold in type IIB theory

$$ds_{\text{string}}^2 = e^{2A} \sum_{\mu=0}^3 dx^\mu dx_\mu + \underbrace{\sum_{m,n=1}^4 g_{mn} dy^m dy^n}_{\text{compact } \mathcal{M}_4} + \underbrace{2e^{2D} |h(z)|^2 dz d\bar{z}}_{\text{CY}_3}$$

with

$$\Omega_3 = h dz \wedge [(dy^4 - \tau dy^1) \wedge (dy^3 - \sigma dy^2) - \beta(dy^1 \wedge dy^4 - dy^2 \wedge dy^3) - \beta^2 dy^1 \wedge dy^2]$$

$$J = dy^1 \wedge dy^4 + dy^2 \wedge dy^3 + \frac{i}{2} e^{2D} |h|^2 dz \wedge d\bar{z}$$

$$\text{with } d\Omega_3 = 0 = dJ$$

Assume that A , D , h and τ , σ , β vary only over z -plane.

Rescaling by e^{-2A} , we obtain $\mathcal{N} = 2$ theory in 4D Minkowski spacetime.

Perform string dualities :

$$\text{CY}_3 \xrightarrow{T_{12}} \text{sol. B} \xrightarrow{S} \text{sol. C} \xrightarrow{T_{14}} \text{sol. A}$$

$$d\Omega_3 = 0 = dJ, \quad e^{2D} = \sigma_2\tau_2 - \beta_2^2$$

$$g_{mn} = e^{-2D} \begin{pmatrix} \sigma_2 & \beta_2 & \beta_2\sigma_1 - \beta_1\sigma_2 & -\beta_1\beta_2 + \sigma_2\tau_1 \\ \beta_2 & \tau_2 & -\beta_1\beta_2 + \sigma_1\tau_2 & \beta_2\tau_1 - \beta_1\tau_2 \\ \beta_2\sigma_1 - \beta_1\sigma_2 & -\beta_1\beta_2 + \sigma_1\tau_2 & \text{Im}(\bar{\beta}^2\sigma) + |\sigma|^2\tau_2 & |\beta|^2\beta_2 + \text{Im}(\beta\bar{\sigma}\tau) \\ -\beta_1\beta_2 + \sigma_2\tau_1 & \beta_2\tau_1 - \beta_1\tau_2 & |\beta|^2\beta_2 + \text{Im}(\beta\bar{\sigma}\tau) & \text{Im}(\bar{\beta}^2\tau) + |\tau|^2\sigma_2 \end{pmatrix}$$

Special case ($\beta = 0$) :

$$ds_{\text{CY}}^2 = \frac{1}{\tau_2} |dy^1 + \tau dy^4|^2 + \frac{1}{\sigma_2} |dy^2 + \sigma dy^3|^2 + 2\sigma_2\tau_2 |h(z)|^2 dzd\bar{z}$$

Perform string dualities :

$$\text{CY}_3 \xrightarrow{T_{12}} \text{sol. B} \xrightarrow{S} \text{sol. C} \xrightarrow{T_{14}} \text{sol. A}$$

$$e^{2D} = e^{2\phi} = \sigma_2 \tau_2 - \beta_2^2, \quad A = 0$$

$$B_{(2)} = \tau_1 dy^1 \wedge dy^4 + \sigma_1 dy^2 \wedge dy^3 - \beta_1 (dy^2 \wedge dy^4 + dy^1 \wedge dy^3)$$

$$g_{mn} = \begin{pmatrix} \tau_2 & -\beta_2 & 0 & 0 \\ -\beta_2 & \sigma_2 & 0 & 0 \\ 0 & 0 & \sigma_2 & -\beta_2 \\ 0 & 0 & -\beta_2 & \tau_2 \end{pmatrix}$$

general systems of intersecting NS5-branes, and their U-duals

All branes are codim-2 in 6D

Perform string dualities :

$$\text{CY}_3 \xrightarrow{T_{12}} \text{sol. B} \xrightarrow{S} \text{sol. C} \xrightarrow{T_{14}} \text{sol. A}$$

$$e^{2D} = e^{-2A} = e^{-\phi} = \sqrt{\sigma_2 \tau_2 - \beta_2^2}$$

$$C_{(2)} = \tau_1 dy^1 \wedge dy^4 + \sigma_1 dy^2 \wedge dy^3 - \beta_1 (dy^2 \wedge dy^4 + dy^1 \wedge dy^3)$$

$$g_{mn} = e^{2A} \begin{pmatrix} \tau_2 & -\beta_2 & 0 & 0 \\ -\beta_2 & \sigma_2 & 0 & 0 \\ 0 & 0 & \sigma_2 & -\beta_2 \\ 0 & 0 & -\beta_2 & \tau_2 \end{pmatrix}$$

general systems of intersecting D5-branes, and their U-duals

All branes are codim-2 in 6D

Perform string dualities :

$$\text{CY}_3 \xrightarrow{T_{12}} \text{sol. B} \xrightarrow{S} \text{sol. C} \xrightarrow{T_{14}} \text{sol. A}$$

$$g_{mn} = e^{\phi-2A} \delta_{mn}, \quad e^{2D} = e^{-2A} = \sqrt{\sigma_2 \tau_2 - \beta_2^2}, \quad e^{-\phi} = \tau_2$$

$$C = \tau_1$$

$$C_{(4)} = \left(-\sigma_1 + \frac{2\beta_1\beta_2}{\tau_2} - \frac{\tau_1\beta_2^2}{\tau_2^2} \right) dy^1 \wedge dy^2 \wedge dy^3 \wedge dy^4$$

$$B_{(2)} = -\frac{\beta_2}{\tau_2} (dy^1 \wedge dy^2 - dy^3 \wedge dy^4)$$

$$C_{(2)} = \left(\beta_1 - \frac{\tau_1\beta_2}{\tau_2} \right) (dy^1 \wedge dy^2 - dy^3 \wedge dy^4)$$

general systems of parallel D3- and D7-branes, and their U-duals

All branes are codim-2 in 6D

In each solution, $\tau(z)$, $\sigma(z)$, $\beta(z)$ can be interpreted as complex structure deformations of **auxiliary K3 surface** fibred over z -plane

$$\mathbb{R}^{1,3} \times \underbrace{\mathcal{M}_4 \times \mathbb{C} \times \text{auxiliary K3}}_{\mathcal{M}_{10}} \leftarrow 14\text{D}$$

with $\tau, \sigma, \beta \in \frac{SO(2,3)}{SO(2) \times SO(3)}$: K3 with Picard number 20 – 3

$$S: \quad \tau \rightarrow -\frac{1}{\tau}, \quad \sigma \rightarrow -\frac{1}{2\tau}\beta^2, \quad \beta \rightarrow \frac{1}{\tau}\beta$$

U-duality $SO(2,3)$ is $T: \tau \rightarrow \tau + 1$

generated by $W: \beta \rightarrow \beta + 1$

$$R: \quad \sigma \leftrightarrow \tau$$

τ, σ, β can be regarded as parameters of genus-2 surface with monodromy $SO(2,3) \simeq Sp(4)$
auxiliary K3 is genus-2 Riemann surface fibred over $\mathbb{C}P^1$

For U-duality invariance and global compactness, we choose

$$e^{2D-2A} |h(z)|^2 dzd\bar{z} = (\sigma_2\tau_2 - \beta_2^2) |h(z)|^2 dzd\bar{z}$$

$$\text{with } h(z) = \left(\frac{\chi_{12}(\mathbf{\Pi})}{\prod_{i=1}^{24} (z - z_i)} \right)^{\frac{1}{12}}$$

$\chi_{12}(\mathbf{\Pi})$: cusp form of weight 12 of genus-2 Riemann surface with $\mathbf{\Pi} = \begin{pmatrix} \sigma & \beta \\ \beta & \tau \end{pmatrix}$

Malmendier, Morrison: arXiv:1406.4873

In a special case $\beta = 0 \rightarrow \tau, \sigma \in \left(\frac{SL(2)}{U(1)} \right)^2$

$$h(z) \rightarrow \frac{\eta(\sigma)^2 \eta(\tau)^2}{\prod_{i=1}^{24} (z - z_i)^{\frac{1}{12}}}$$

In both cases, the number of branes introduced is 24.

An example of auxiliary K3 with Picard number $20 - 2$ (2 complex deformations)

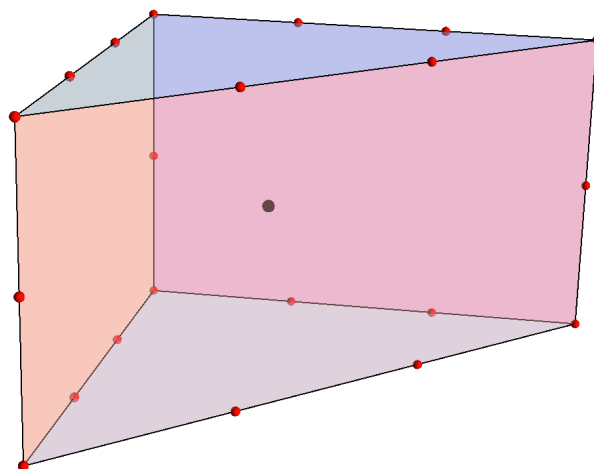

This K3 is fibred over $\mathbb{C}P^1$.

At degeneration point of K3 (or its subspace), the symmetry is enhanced.

This symmetry enhancement can be seen as the edges in the above polyhedron.

(Any details are skipped, sorry!)

Figures from Candelas, Constantin, Damian, Larfors, Morales: arXiv:1411.4785

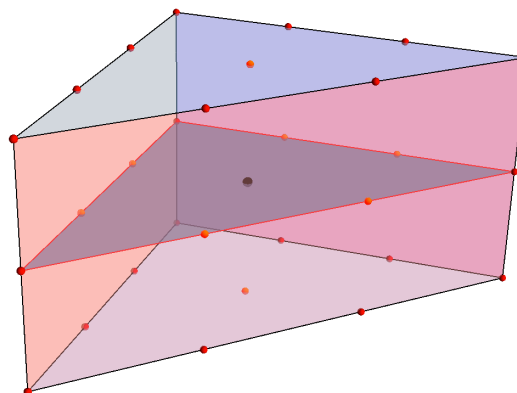

A sub-polyhedron describing elliptic curve in K3

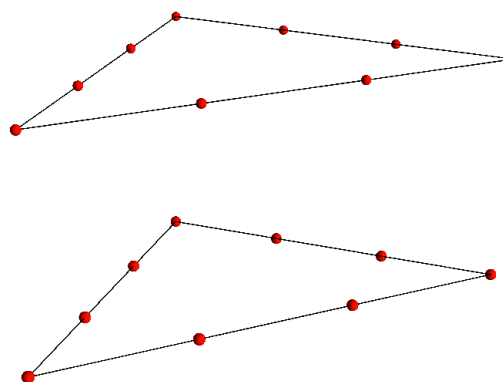

Affine Dynkin diagram for $SU(9) \times SU(9)$
 Each symmetry appears at each degeneration point.

Figures from Candelas, Constantin, Damian, Larfors, Morales: arXiv:1411.4785

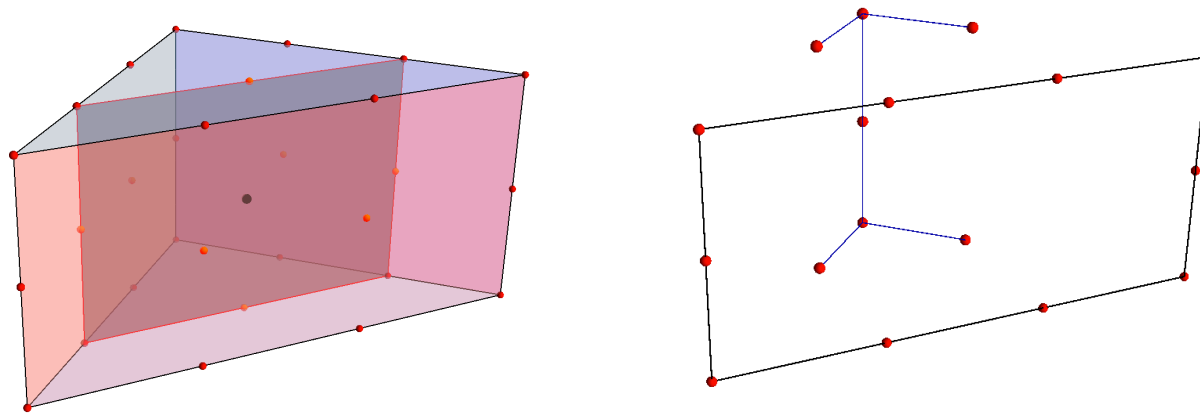

$$SO(12) \times SU(10)$$

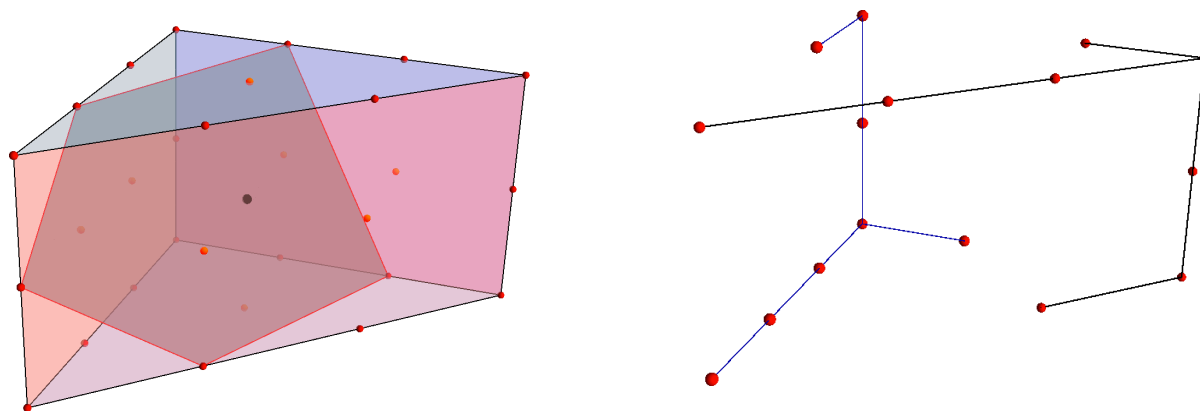

$$E_7 \times E_7$$

Figures from Candelas, Constantin, Damian, Larfors, Morales: arXiv:1411.4785

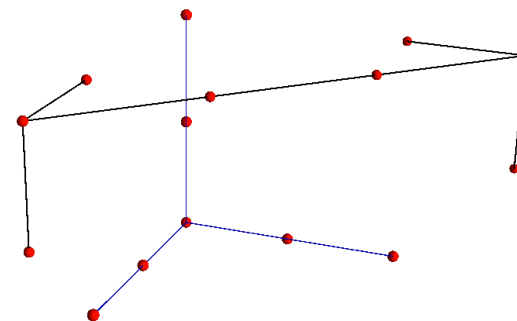
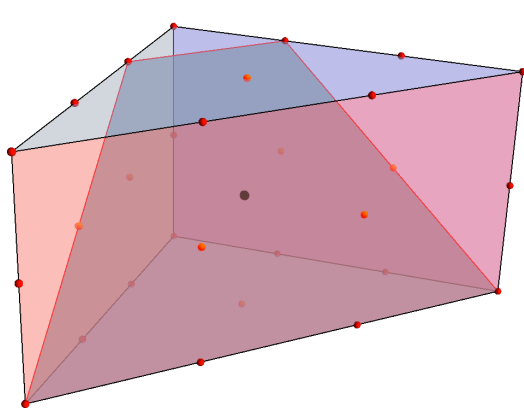

$$SO(14) \times E_6$$

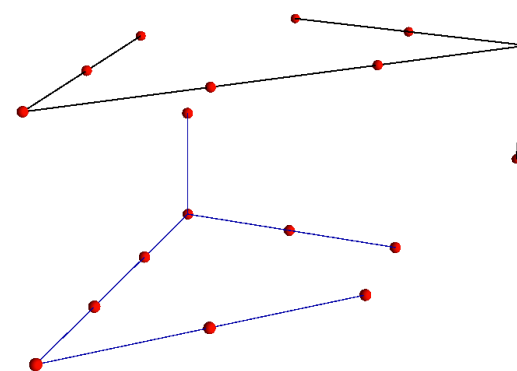
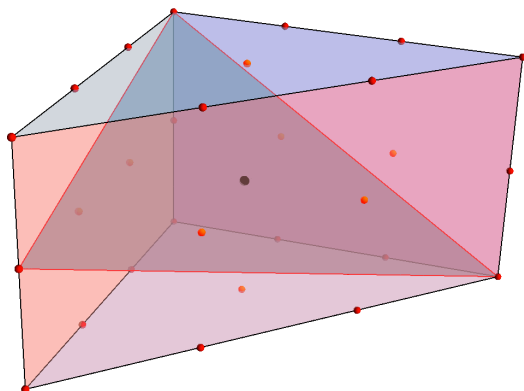

$$E_8 \times E_8$$

Figures from Candelas, Constantin, Damian, Larfors, Morales: [arXiv:1411.4785](https://arxiv.org/abs/1411.4785)

In any case, the space $\mathcal{M}_{10} = \mathcal{M}_4 \times \text{auxiliary K3} \times \mathbb{C}P^1$ is compact.

In order to balance the energy in \mathcal{M}_{10} , we should introduce orientifold-planes.

The O-planes should also be given by codim-2 branes, in such a way that

$O7^- = \text{colliding B- and C-branes in F-theory.}$

Sen: hep-th/9605150

	B	C
sol.A	$[1, -1]_{d3}^E, [1, -1]_7^S$	$[1, 1]_{d3}^E, [1, 1]_7^S$
sol.B	$[1, -1]_{s5}^T$	$[1, +1]_{s5}^T$
sol.C	$[1, -1]_{d5}^E$	$[1, +1]_{d5}^E$

Each is an **exotic** $SL(2, \mathbb{Z})$ pair (a subgroup of U-duality)

$[1, 0]_{dp}^E$: defect Dp $[0, 1]_{dp}^E$: exotic p_3^{7-p} $[1, 0]_{s5}^T$: defect NS5 $[0, 1]_{s5}^T$: exotic 5_2^2 $[p, q]_7^S$: $[p, q]$ 7-brane

4. Summary and discussions

- Exotic branes are codim-2 objects in D -dim string theory.
- Exotic $SL(2, \mathbb{Z})$ monodromy and its extension.
- Towards 6D $\mathcal{N} = (2, 0)$ and 4D $\mathcal{N} = 2$ via generating orientifold planes.
- Genuinely exotic configurations? (by exceptional field theory)
- Quantitative predictions?

Thanks

Appendix

Consider charged particles in $D \geq 4$ maximal supergravity :

of charged particles = # of $U(1)$ gauge one-form potentials

They can be regarded as standard branes (D p , NS5, KK5, F1, P)
 (un)wrapped on torus T^{10-D} in type II string theory

D	#	IIB	IIA
10A	1	–	D0 ₍₁₎
10B	0	–	–
9	3	D1 ₍₁₎ F1 ₍₁₎ P ₍₁₎	F1 ₍₁₎ D0 ₍₁₎ P ₍₁₎
8	3×2	D1 ₍₂₎ F1 ₍₂₎ P ₍₂₎	D2 ₍₁₎ F1 ₍₂₎ D0 ₍₁₎ P ₍₂₎
7	10	D3 ₍₁₎ D1 ₍₃₎ F1 ₍₃₎ P ₍₃₎	D2 ₍₃₎ F1 ₍₃₎ D0 ₍₁₎ P ₍₃₎
6	16	D3 ₍₄₎ D1 ₍₄₎ F1 ₍₄₎ P ₍₄₎	D4 ₍₁₎ D2 ₍₆₎ F1 ₍₄₎ D0 ₍₁₎ P ₍₄₎
5	27	D5 ₍₁₎ NS5 ₍₁₎ D3 ₍₁₀₎ D1 ₍₅₎ F1 ₍₅₎ P ₍₅₎	NS5 ₍₁₎ D4 ₍₅₎ D2 ₍₁₀₎ F1 ₍₅₎ D0 ₍₁₎ P ₍₅₎
4	28×2	D5 ₍₆₎ NS5 ₍₆₎ KK5 ₍₆₎ D3 ₍₂₀₎ D1 ₍₆₎ F1 ₍₆₎ P ₍₆₎	D6 ₍₁₎ NS5 ₍₆₎ KK5 ₍₆₎ D4 ₍₁₅₎ D2 ₍₁₅₎ F1 ₍₆₎ D0 ₍₁₎ P ₍₆₎

Transformations via string duality :

$$\begin{array}{ll}
 \mathbf{T}_y : & R_y \rightarrow \frac{\ell_s^2}{R_y}, \quad g_s \rightarrow \frac{\ell_s}{R_y} g_s \\
 \mathbf{S} : & g_s \rightarrow \frac{1}{g_s}, \quad \ell_s^2 \rightarrow g_s \ell_s^2
 \end{array}
 \quad
 \begin{array}{l}
 R_y : \text{ compact radius of } y\text{-direction} \\
 g_s : \text{ string coupling constant} \\
 \ell_s : \text{ string length}
 \end{array}$$

$$\text{tension of } b_n^c = \frac{R_1 R_2 \cdots R_b (R_{b+1} \cdots R_{b+c})^2}{g_s^n \ell_s^{b+2c+1}}$$

$$\text{tension of } b_n^{(d,c)} = \frac{R_1 R_2 \cdots R_b (R_{b+1} \cdots R_{b+c})^2 (R_{b+c+1} \cdots R_{b+c+d})^3}{g_s^n \ell_s^{b+2c+3d+1}}$$

of defect branes of codim-2 in D -dim ($\equiv n_D$)

= # of supersymmetric Wess-Zumino couplings

= $\dim G - (\text{rank } T + 1)$

= $\dim G - \text{rank } G$

= $2 \times \#$ of $(D - 2)$ -form central charges in maximal SUSY algebra
 = $\dim H$

D	n_D	G	H	T
10A	0	\mathbb{R}^+	1	1
10B	2	$SL(2, \mathbb{R})$	$SO(2)$	1
9	2	$SL(2, \mathbb{R}) \times \mathbb{R}^+$	$SO(2) \times \mathbb{R}^+$	$SO(1, 1)$
8	$6 + 2$	$SL(3, \mathbb{R}) \times SL(2, \mathbb{R})$	$SO(3) \times SO(2)$	$SO(2, 2)$
7	20	$SL(5, \mathbb{R})$	$SO(5)$	$SO(3, 3)$
6	40	$SO(5, 5)$	$SO(5) \times SO(5)$	$SO(4, 4)$
5	72	$E_{6(6)}$	$USp(8)$	$SO(5, 5)$
4	126	$E_{7(7)}$	$SU(8)$	$SO(6, 6)$
3	240	$E_{8(8)}$	$SO(16)$	$SO(7, 7)$

IIB action in Einstein frame :

$$S_{\text{IIB}} = \frac{1}{2\kappa^2} \int d^{10}x \sqrt{-G_E} \left\{ R_E - \frac{\partial_M \bar{\tau} \partial^M \tau}{2(\tau_2)^2} - \frac{1}{2} F_{(3)}^i \cdot \mathcal{M}_{ij} F_{(3)}^j - \frac{1}{4} |\tilde{F}_{(5)}|^2 \right\} - \frac{\epsilon_{ij}}{8\kappa^2} \int C_{(4)} \wedge F_{(3)}^i \wedge F_{(3)}^j$$

$$\tau \equiv C + i e^{-\phi} \equiv \tau_1 + i\tau_2, \quad \mathcal{M}_{ij} \equiv \frac{1}{\tau_2} \begin{pmatrix} 1 & -\tau_1 \\ -\tau_1 & |\tau|^2 \end{pmatrix}$$

$$F_{(3)}^i \equiv \begin{pmatrix} dC_{(2)} \\ dB_{(2)} \end{pmatrix}, \quad \tilde{F}_{(5)} \equiv dC_{(4)} - \frac{1}{2} C_{(2)} \wedge H_{(3)} + \frac{1}{2} B_{(2)} \wedge F_{(3)}$$

$SL(2, \mathbb{Z})$ S-duality

$$\tau \rightarrow \frac{a\tau + b}{c\tau + d}, \quad \Lambda^i_j = \begin{pmatrix} a & b \\ c & d \end{pmatrix} \in SL(2, \mathbb{Z})$$

$$F_{(3)}^i \rightarrow \Lambda^i_j F_{(3)}^j, \quad \tilde{F}_{(5)} \rightarrow \tilde{F}_{(5)}, \quad G_{MN}^E \rightarrow G_{MN}^E$$

$$\mathcal{M} \rightarrow \Lambda^{-T} \mathcal{M} \Lambda^{-1}$$

Monodromy matrix $K_{[1,0]}$ is transformed to $K_{[p,q]}$ for $[p,q]$ 7-brane :

$$\begin{pmatrix} 1 \\ 0 \end{pmatrix} \rightarrow g \begin{pmatrix} 1 \\ 0 \end{pmatrix} = \begin{pmatrix} p \\ q \end{pmatrix}, \quad g = \begin{pmatrix} p & r \\ q & s \end{pmatrix} \in SL(2, \mathbb{Z})$$

$$K_{[p,q]} = g K_{[1,0]} g^{-1} = \begin{pmatrix} 1 + pq & -p^2 \\ q^2 & 1 - pq \end{pmatrix}$$

ex) monodromy $K_{[0,1]}$ for 7_3 -brane : $K_{[0,1]} = \begin{pmatrix} 1 & 0 \\ 1 & 1 \end{pmatrix}$

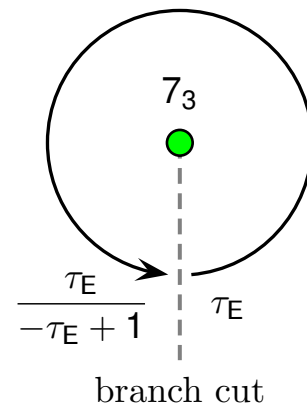

$$\tau_E = -\frac{1}{\tau_{D7}}$$

$|\mathrm{tr}K|$ is a good character to classify defect branes :

$$K \cdot \tau_* = \frac{a\tau_* + b}{c\tau_* + d} = \tau_*, \quad K = \begin{pmatrix} a & b \\ c & d \end{pmatrix} \in SL(2, \mathbb{Z})$$

$$\therefore \tau_* = \frac{1}{2c} \left\{ (a - d) \pm \sqrt{(\mathrm{tr}K)^2 - 4} \right\}$$

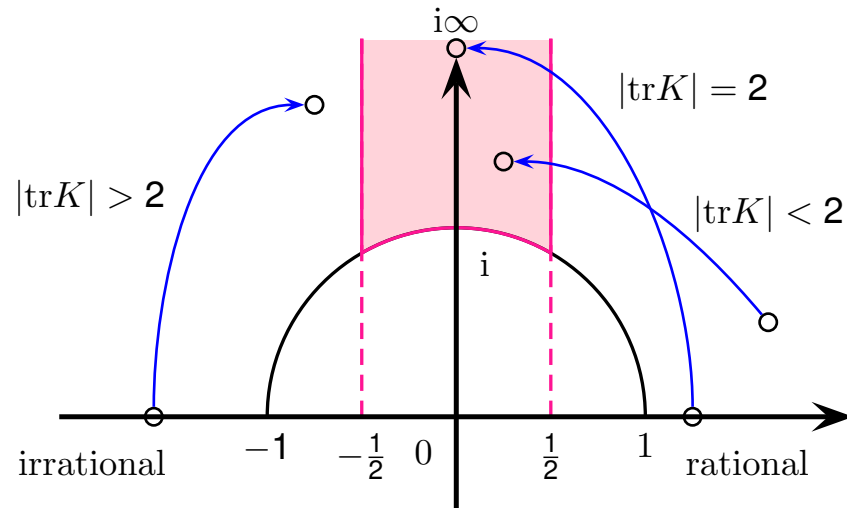

$|\mathrm{tr}K| = 2$: parabolic (collapsible)

$|\mathrm{tr}K| < 2$: elliptic (collapsible)

$|\mathrm{tr}K| > 2$: hyperbolic (non-collapsible)

trK	monodromy	branes	collapsible?	symmetry	type
+2	$T^{-n} = K_A^n$	A^n	yes	$A_{n-1} (n \geq 1)$	I_n
	$\mathbb{1} = T^0 = K_C K_B K_C K_B K_A^8$	$\widehat{E}_9 \equiv A^8 BCBC$	yes	\widehat{E}_9	I_0
	$T^{ n } = K_C K_B K_C K_B K_A^{8- n }$	$A^{8- n } BCBC$	no	$\widehat{E}_{9- n } (n \leq -1)$	
+1	$ST \sim K_C K_A$	$H_0 \equiv AC$	yes	H_0	II
	$(ST)^{-1} \sim K_C^2 K_B K_A^7$	$E_8 \equiv A^7 BC^2$	yes	E_8	II^*
0	$S \sim K_C K_A^2$	$H_1 \equiv A^2 C$	yes	H_1	III
	$-S \sim K_C^2 K_B K_A^6$	$E_7 \equiv A^6 BC^2$	yes	E_7	III^*
-1	$-(ST)^{-1} \sim K_C K_A^3$	$H_2 \equiv A^3 C$	yes	H_2	IV
	$-ST \sim K_C^2 K_B K_A^5$	$E_6 \equiv A^5 BC^2$	yes	E_6	IV^*
-2	$-T^{-n} = K_C K_B K_A^{n+4}$	$D_{n+4} \equiv A^{n+4} BC$	yes	$D_{n+4} (n \geq 1)$	I_n^*
	$-\mathbb{1} = -T^0 = K_C K_B K_A^4$	$D_4 \equiv A^4 BC$	yes	D_4	I_0^*
	$-T = K_C K_B K_A^3$	$A^3 BC$	no	D_3	
	$-T^2 = K_C K_B K_A^2$	$A^2 BC$	no	D_2	
	$-T^3 = K_C K_B K_A$	ABC	no	D_1	
	$-T^4 = K_C K_B$	BC	no	—	

$$T = \begin{pmatrix} 1 & 1 \\ 0 & 1 \end{pmatrix} \quad S = \begin{pmatrix} 0 & -1 \\ 1 & 0 \end{pmatrix} \quad A = [1, 0]\text{-brane} \quad B = [1, -1]\text{-brane} \quad C = [1, +1]\text{-brane}$$

Consider a D-string crossing the branch cut of D7-brane from the left.
 A new string and a junction appear by Hanany-Witten transition.

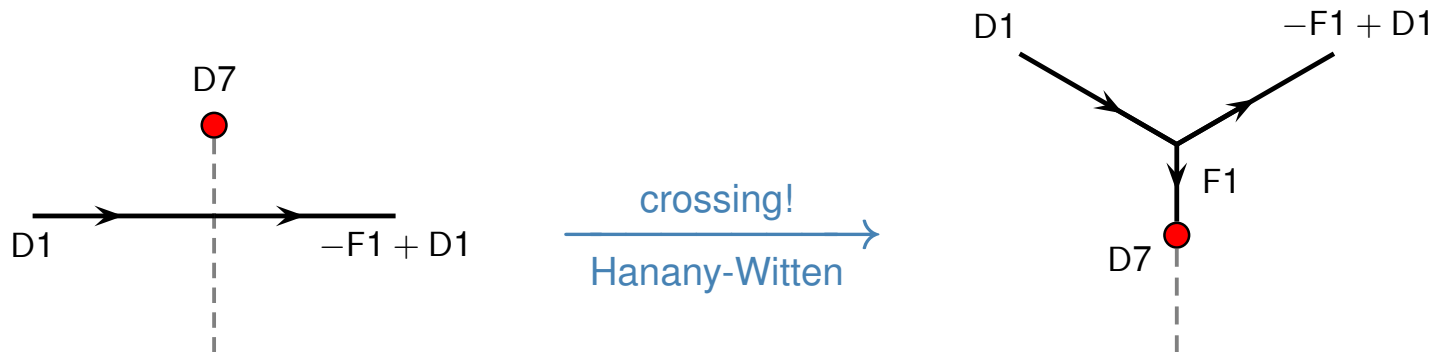

Note: D7-brane is stretched in 1234567-directions.

This is a string junction in F-theory.

Gaberdiel and Zwiebach: [hep-th/9709013](https://arxiv.org/abs/hep-th/9709013)

DeWolfe and Zwiebach: [hep-th/9804210](https://arxiv.org/abs/hep-th/9804210)

etc..

[Generalization]

(r, s) -string crossing the branch cut of $[p, q]$ 7-brane :



w/ charge conservation law : $qr - ps = \pm 1$

Consider a D3-brane wrapped on two-torus (wD3) and **defect** NS5-brane (dNS5).

If dNS5 goes across wD3,

a new D-string and a junction appear by Hanany-Witten transition.

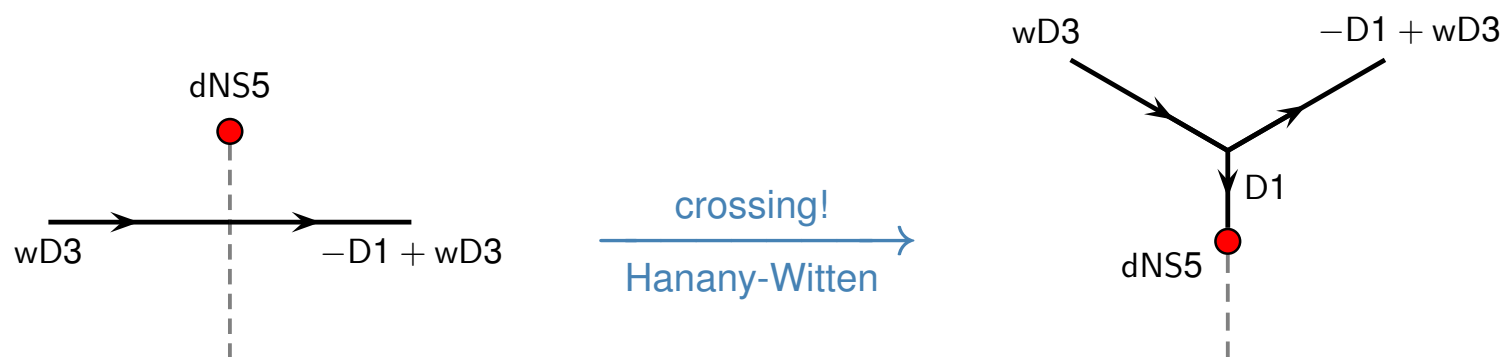

defect b -brane : b -brane of codim-**2** in $(b + 3)$ -dim

Consider a D-string and 5_2^2 -brane.

D-string charge is jumped by monodromy.

If 5_2^2 -brane goes across D-string,

a new wD3 and a junction appear (Hanany-Witten transition).

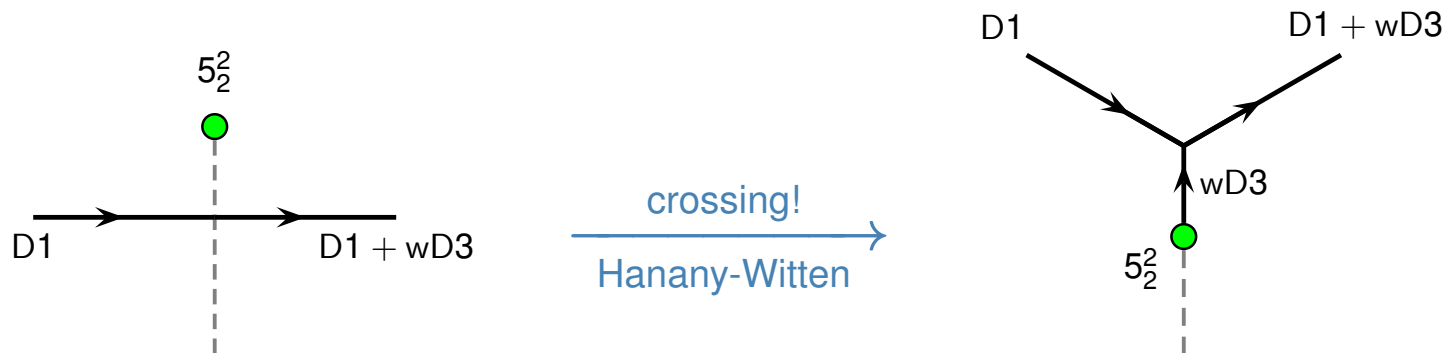

- defect NS5-brane and D5-brane wrapped on two-torus :

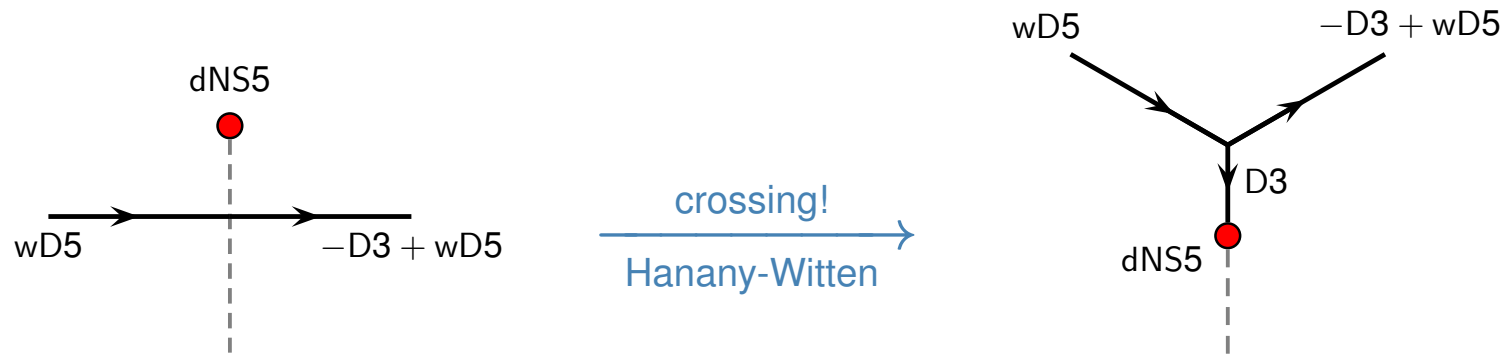

- 5_2^2 -brane and D3-brane :

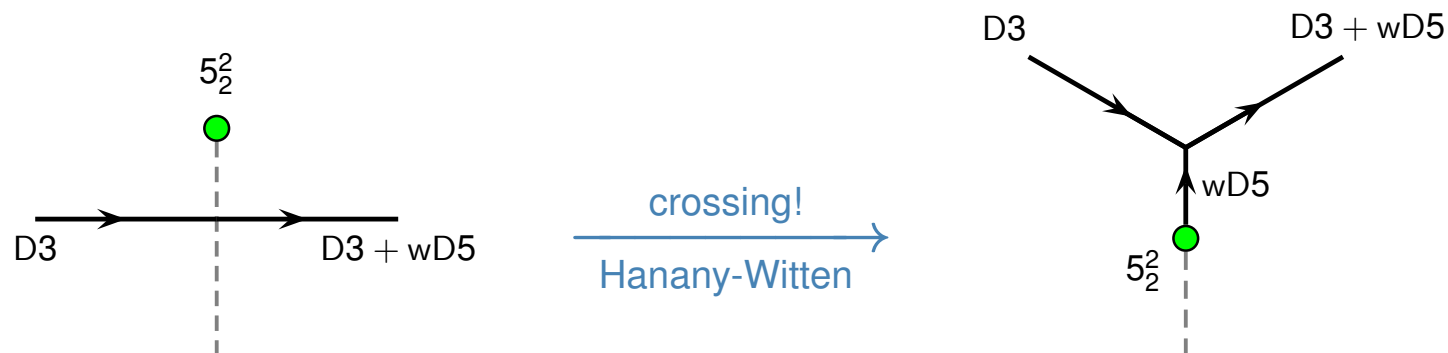

Example of brane configurations with 7-branes :

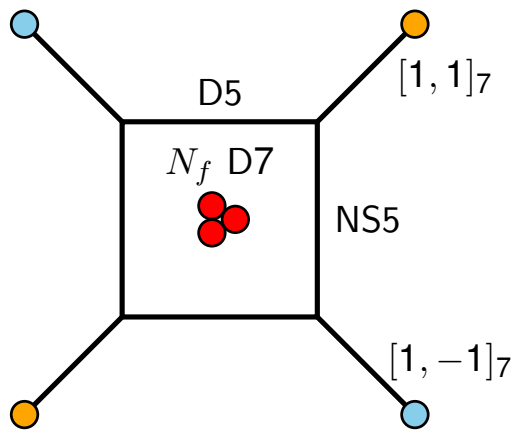

5D $\mathcal{N} = 1$ $SU(2)$ gauge theory on 5-brane web
with N_f D7-branes

→ SCFT with E_{N_f+1} symmetry

Symmetry is purely determined by the singularity of fibers :

Kodaira classification (ADE-type singularity on K3 surface)

Seiberg: [hep-th/9608111](https://arxiv.org/abs/hep-th/9608111)

Aharony, Hanany: [hep-th/9704170](https://arxiv.org/abs/hep-th/9704170)

DeWolfe, Hanany, Iqbal, Katz: [hep-th/9902179](https://arxiv.org/abs/hep-th/9902179)

5D $\mathcal{N} = 1$ SCFT from $SU(2)$ gauge theory with N_f flavors :

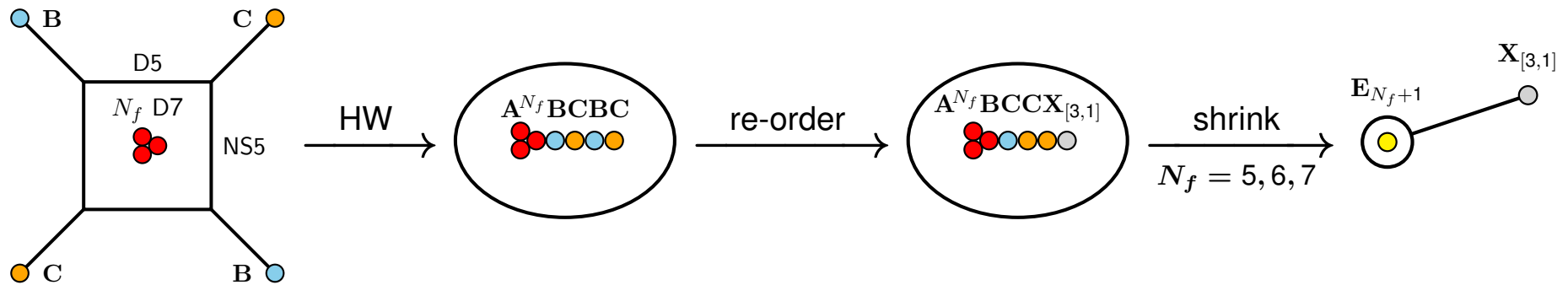

A : D7-brane, B : $[1, -1]_7$ -brane, C : $[1, 1]_7$ -brane

N_f	0	1	2	3	4	5	6	7
SCFT :	E_1	E_2	E_3	E_4	E_5			
						E_6	E_7	E_8
	A_1	$A_1 \times U(1)$	$A_2 \times A_1$	A_4	D_5			

They are purely determined by the singularity of fibers :

Kodaira classification (ADE-type singularity on K3 surface)

DeWolfe, Hanany, Iqbal, Katz: hep-th/9902179

5D theory on 5-branes with $N_f = 5$ D7-branes :

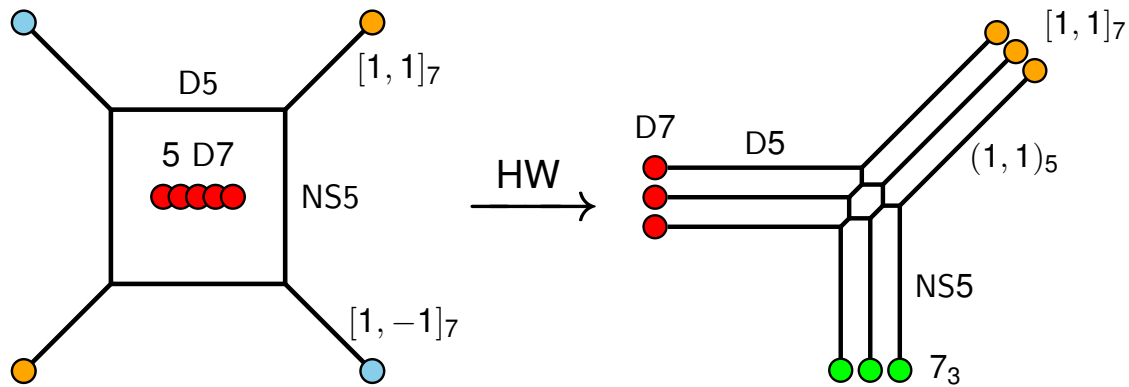

IIB	0	1	2	3	4	5	6	7	8	9
5 D7	-	-	-	-	-	-	-	-	-	-
D5	-	-	-	-	-				-	
NS5	-	-	-	-	-					-
$(1, 1)_5$	-	-	-	-	-				angle	

— 5D theory —

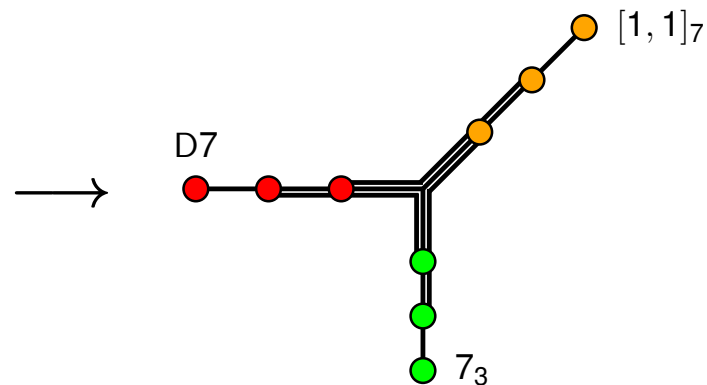

5D T_3 theory with E_6 symmetry

Gaiotto, Witten: [arXiv:0804.2902](https://arxiv.org/abs/0804.2902), [0807.3720](https://arxiv.org/abs/0807.3720)
 Benini, Benvenuti, Tachikawa: [arXiv:0906.0359](https://arxiv.org/abs/0906.0359)

D7-branes and 7_3 -branes are involved.

3D theory on 3-branes with 5 defect D5-branes :

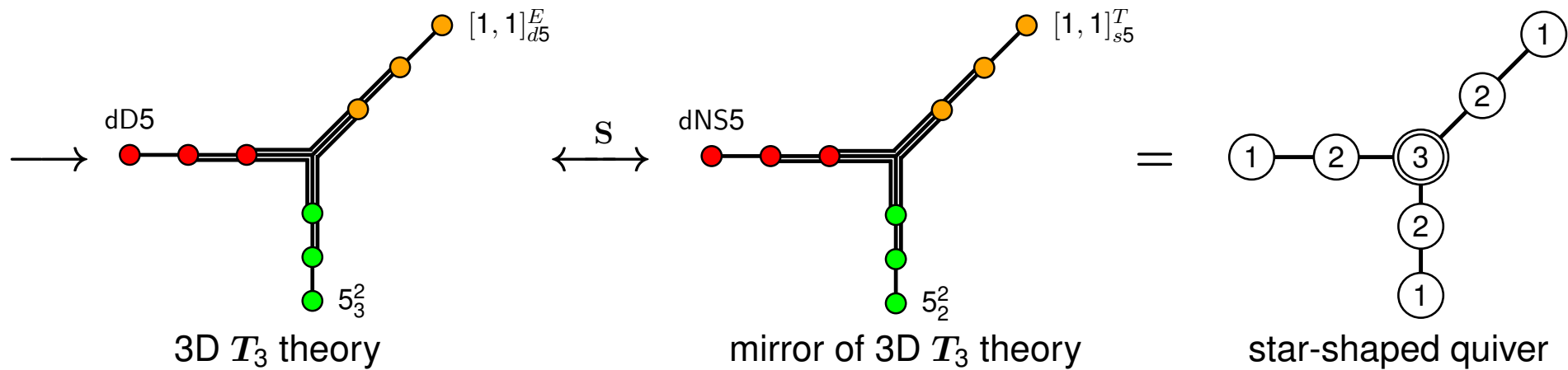
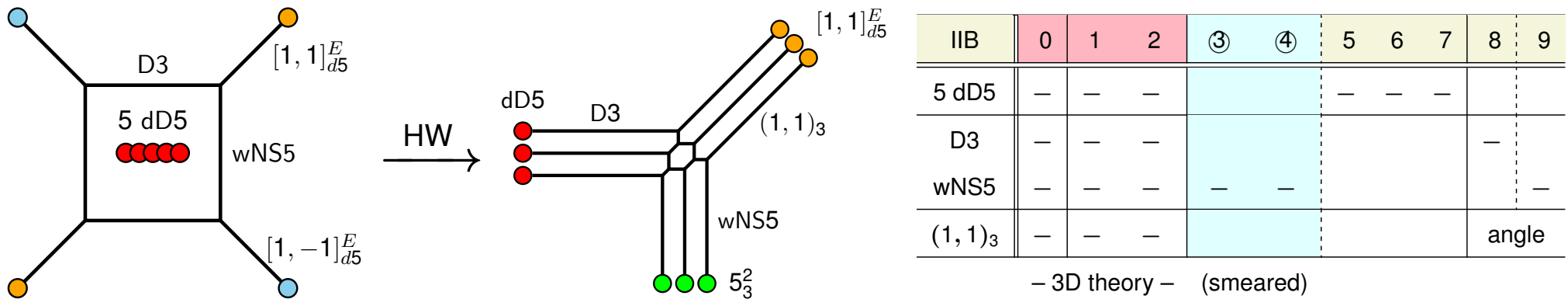

(dD5, 5_3^2) and (dNS5, 5_2^2) are involved.

Intriligator, Seiberg: [hep-th/9609207](https://arxiv.org/abs/hep-th/9609207)
 Benini, Tachikawa, Xie: [arXiv:1007.0992](https://arxiv.org/abs/1007.0992)

- D7(1234567) :

$$z = x^8 + ix^9 = r e^{i\vartheta}$$

$$ds^2 = \frac{1}{(\tau_2)^{1/2}} dx_{01234567}^2 + (\tau_2)^{1/2} |f|^2 dz d\bar{z}$$

$$e^{2\phi} = (\tau_2)^{-2}$$

$$C_{(0)} = \tau_1$$

$$C_{(8)} = -\frac{1}{\tau_2} dx^0 \wedge dx^1 \wedge \dots \wedge dx^7$$

$$\tau(z) = \tau_1 + i\tau_2 = C_{(0)} + ie^{-\phi} = \frac{\vartheta}{2\pi} + \frac{i}{2\pi} \log \frac{\Lambda}{r}$$

- $7_3(1234567)$:

$$ds'^2 = \frac{1}{(\tau'_2)^{1/2}} dx_{01234567}^2 + (\tau'_2)^{1/2} |f'|^2 dz d\bar{z}$$

$$e^{2\phi'} = (\rho'_2)^{-2}$$

$$C'_{(0)} = \tau'_1, \quad C'_{(8)} = -\frac{1}{\tau'_2} dx^0 \wedge dx^1 \wedge \dots \wedge dx^7$$

$$\tau'(z) = \tau'_1 + i\tau'_2 = C'_{(0)} + ie^{-\phi'} = -\frac{1}{\tau_{D7}}$$

$$\tau'_1 = -\frac{\tau_1}{|\tau|^2}, \quad \tau'_2 = \frac{\tau_2}{|\tau|^2}$$

$$\tau'_2 |f'|^2 = \tau_2 |f|^2, \quad |f'| = |\tau| |f|$$

- defect NS5(12345) smeared along 67-directions :

$$z = x^8 + ix^9 = r e^{i\vartheta}$$

$$ds^2 = dx_{012345}^2 + \rho_2 dx_{67}^2 + \rho_2 |f|^2 dz d\bar{z}$$

$$e^{2\phi} = \rho_2$$

$$B_{(2)} = \rho_1 dx^6 \wedge dx^7, \quad B_{(6)} = \frac{1}{\rho_2} dx^0 \wedge dx^1 \wedge \dots \wedge dx^5$$

$$\rho(z) = \rho_1 + i\rho_2 = B_{67}^{(2)} + ie^{2\phi} = B_{67}^{(2)} + i\sqrt{\det G_{mn}} = \frac{\vartheta}{2\pi} + \frac{i}{2\pi} \log \frac{\Lambda}{r}$$

$$\tau = (\text{complex structure of } T_{67}^2) = i$$

$$m, n = 6, 7$$

- $5_2^2(12345,67)$:

$$ds'^2 = dx_{012345}^2 + \rho'_2 dx_{67}^2 + \rho'_2 |f'|^2 dz d\bar{z}$$

$$e^{2\phi'} = \rho'_2$$

$$B'_{(2)} = \rho'_1 dx^6 \wedge dx^7, \quad B'_{(6)} = \frac{1}{\rho'_2} dx^0 \wedge dx^1 \wedge \dots \wedge dx^5$$

$$\rho'(z) = \rho'_1 + i\rho'_2 = B'_{67}{}^{(2)} + ie^{2\phi'} = B'_{67}{}^{(2)} + i\sqrt{\det G'_{mn}} = -\frac{1}{\rho_{\text{NS5}}}$$

$$\rho'_1 = -\frac{\rho_1}{|\rho|^2}, \quad \rho'_2 = \frac{\rho_2}{|\rho|^2}$$

$$\tau' = (\text{complex structure of } \tilde{T}_{67}^2) = i = -\frac{1}{\tau_{\text{NS5}}}$$

$$\rho'_2 |f'|^2 = \rho_2 |f|^2, \quad m, n = 6, 7$$

- defect KK5(12345,7) smeared along 67-directions :

$$ds^2 = dx_{012345}^2 + \tau_2 dx_6^2 + \frac{1}{\tau_2} (dx^7 - \tau_1 dx^6)^2 + \tau_2 |f|^2 dz d\bar{z}$$

$$e^{2\phi} = 1, \quad B_{(2)} = 0, \quad B_{(6)} = 0$$

$$\rho = \rho_1 + i\rho_2 = B_{67}^{(2)} + i\sqrt{\det G_{mn}} = i$$

$$\tau(z) = (\text{complex structure of } T_{67}^2) = \tau_1 + i\tau_2 = \frac{\vartheta}{2\pi} + \frac{i}{2\pi} \log \frac{\Lambda}{r}$$

$$m, n = 6, 7$$

- defect D3(123) smeared along 4567-directions :

$$z = x^8 + ix^9 = r e^{i\vartheta}$$

$$ds^2 = \frac{1}{(\tau_2)^{1/2}} dx_{0123}^2 + (\tau_2)^{1/2} dx_{4567}^2 + (\tau_2)^{1/2} |f|^2 dz d\bar{z}$$

$$e^{2\phi} = 1$$

$$\tilde{C}_{(4)} = \tau_1 dx^4 \wedge dx^5 \wedge dx^6 \wedge dx^7$$

$$C_{(4)} = -\frac{1}{\tau_2} dx^0 \wedge dx^1 \wedge dx^2 \wedge dx^3$$

$$\tau(z) = \tau_1 + i\tau_2 = \tilde{C}_{4567}^{(4)} + i\sqrt{\det G_{mn}}$$

$$m, n = 4, 5, 6, 7$$

- $3_3^4(123, 4567)$:

$$ds'^2 = \frac{1}{(\tau'_2)^{1/2}} dx_{0123}^2 + (\tau'_2)^{1/2} dx_{4567}^2 + (\tau'_2)^{1/2} |f'|^2 dz d\bar{z}$$

$$e^{2\phi'} = 1$$

$$\tilde{C}'_{(4)} = \tau'_1 dx^4 \wedge dx^5 \wedge dx^6 \wedge dx^7, \quad C'_{(4)} = -\frac{1}{\tau'_2} dx^0 \wedge dx^1 \wedge dx^2 \wedge dx^3$$

$$\tau'(z) = \tau'_1 + i\tau'_2 = \tilde{C}'_{4567} + i\sqrt{\det G'_{mn}} = -\frac{1}{\tau_{D3}}$$

$$\tau'_1 = -\frac{\tau_1}{|\tau|^2}, \quad \tau'_2 = \frac{\tau_2}{|\tau|^2}$$

$$\tau'_2 |f'|^2 = \tau_2 |f|^2, \quad |f'| = |\tau| |f|, \quad m, n = 4, 5, 6, 7$$

- defect $Dp(12 \cdots p)$ smeared along $a_1 \cdots a_{7-p}$ -directions : $z = x^8 + ix^9 = r e^{i\vartheta}$

$$ds^2 = \frac{1}{(\tau_2)^{1/2}} dx_{012 \cdots p}^2 + (\tau_2)^{1/2} dx_{a_1 \cdots a_{7-p}}^2 + (\tau_2)^{1/2} |f|^2 dz d\bar{z}$$

$$e^{2\phi} = (\tau_2)^{\frac{3-p}{2}}$$

$$C_{(7-p)} = \tau_1 dx^{a_1} \wedge \cdots \wedge dx^{a_{7-p}}$$

$$C_{(p+1)} = -\frac{1}{\tau_2} dx^0 \wedge dx^1 \wedge \cdots \wedge dx^p$$

$$\tau(z) = \tau_1 + i\tau_2 = C_{a_1 \cdots a_{7-p}}^{(7-p)} + ie^{\frac{4}{3-p}\phi} = C_{a_1 \cdots a_{7-p}}^{(7-p)} + ie^{-\phi} \sqrt{\det G_{mn}}$$

$$m, n = a_1, \dots, a_{7-p}$$

- $p_3^{7-p}(12 \cdots p, a_1 \cdots a_{7-p})$:

$$ds'^2 = \frac{1}{(\tau'_2)^{1/2}} dx_{012 \cdots p}^2 + (\tau'_2)^{1/2} dx_{a_1 \cdots a_{7-p}}^2 + (\tau'_2)^{1/2} |f'|^2 dz d\bar{z}$$

$$e^{2\phi'} = (\tau'_2)^{\frac{3-p}{2}}$$

$$C'_{(7-p)} = \tau'_1 dx^{a_1} \wedge \cdots \wedge dx^{a_{7-p}}, \quad C'_{(p+1)} = -\frac{1}{\tau'_2} dx^0 \wedge dx^1 \wedge \cdots \wedge dx^p$$

$$\tau'(z) = \tau'_1 + i\tau'_2 = C'_{a_1 \cdots a_{7-p}}^{(7-p)} + ie^{\frac{4}{3-p}\phi'} = -\frac{1}{\tau_{Dp}}$$

$$\tau'_1 = -\frac{\tau_1}{|\tau|^2}, \quad \tau'_2 = \frac{\tau_2}{|\tau|^2}$$

$$\tau'_2 |f'|^2 = \tau_2 |f|^2, \quad |f'| = |\tau| |f|, \quad m, n = a_1, \dots, a_{7-p}$$

- defect F1(1) smeared along 234567-directions :

$$ds^2 = \frac{1}{\rho_2} dx_{01}^2 + dx_{234567}^2 + |f|^2 dzd\bar{z}$$

$$e^{2\phi} = \frac{1}{\rho_2}$$

$$B_{(6)} = \rho_1 dx^2 \wedge dx^3 \wedge \cdots \wedge dx^7, \quad B_{(2)} = -\frac{1}{\rho_2} dx^0 \wedge dx^1$$

$$\rho(z) = \rho_1 + i\rho_2 = B_{234567}^{(6)} + ie^{-2\phi}$$

- $1_4^6(1,234567)$:

$$ds'^2 = \frac{1}{\rho'_2} dx_{01}^2 + dx_{234567}^2 + |f'|^2 dzd\bar{z}$$

$$e^{2\phi'} = \frac{1}{\rho'_2}$$

$$B'_{(6)} = \rho'_1 dx^2 \wedge dx^3 \wedge \dots \wedge dx^7, \quad B'_{(2)} = -\frac{1}{\rho'_2} dx^0 \wedge dx^1$$

$$\rho'(z) = \rho'_1 + i\rho'_2 = B'^{(6)}_{234567} + ie^{-2\phi'} = -\frac{1}{\rho_{F1}}$$

$$\rho'_2 |f'|^2 = \rho_2 |f|^2, \quad |f'| = |\rho| |f|$$

- defect P smeared along 1234567-directions :

$$ds^2 = -2dx^0 dx^1 + \rho_2 dx_1^2 + dx_{234567}^2 + |f|^2 dz d\bar{z}$$

$$e^{2\phi} = \frac{1}{\rho_2}, \quad B_{(2)} = 0, \quad B_{(6)} = 0$$

$$\rho(z) = \rho_1 + i\rho_2 = ie^{-2\phi}$$

- $0_4^{(1,6)}(,234567,1)$:

$$ds^2 = -2dx^0 dx^1 + \rho'_2 dx_1^2 + dx_{234567}^2 + |f'|^2 dz d\bar{z}$$

$$e^{2\phi'} = \frac{1}{\rho'_2} = \frac{|\rho|^2}{\rho_2}, \quad B'_{(2)} = 0, \quad B'_{(6)} = 0$$

$$\rho'(z) = \rho'_1 + i\rho'_2 = ie^{-2\phi'} = -\frac{1}{\rho_P}, \quad \rho'_2 |f'|^2 = \rho_2 |f|^2, \quad |f'| = |\rho| |f|$$