

COMET and Muon $g-2$ /EDM Summer Student Project Report

Hadyan L. Prihadi^{1,a}

¹Theoretical High Energy Physics, THEPI Division, Institut Teknologi Bandung, Jl. Ganeca 10 Bandung, Indonesia.

E-mail: ^ahadyanluthfanp@students.itb.ac.id

Abstract. In this article, we present some works on the detector part of COMET (COherent Muon to Electron Transition) experiment. The detector system of the COMET experiment uses scintillating materials and photodetectors in general. We apply high voltage input and measure the Gain of a photodetector named MPPC (Multi Pixel Photon Counter) and it is linearly dependent with the high voltage input. After that, we attach an LYSO (Lutetium-Yttrium Oxyorthosilicate) crystal as a scintillating material to the MPPC and then measure the natural radioactive process at around 597 keV energy spectrum and also detect the presence of cosmic-ray muons at around 28.4 MeV energy spectrum.

Keywords: COMET, Experimental High Energy Physics, MPPC, LYSO, Particle Detector

1. Introduction

Muon is one of the elementary particles and considered as one of the leptons. It has similarities with an electron such as the charge is $-1e$ (where $e = 1.602 \times 10^{-19}$ is electron charge) and has spin of $1/2$. However, muon has much greater mass than electron with approximately $105.6584 \text{ MeV}/c^2$ rest mass. According to the standard model of particle physics and because of a relatively short mean lifetime ($2.2 \mu\text{s}$), a muon will likely decay into an electron e^- , an electron antineutrino $\bar{\nu}_e$, and a muon neutrino ν_μ ($\mu \rightarrow \nu_\mu \bar{\nu}_e e$). Such decay process involves weak interaction and can be described by a Feynman diagram in Figure 1.

In KEK/High Energy Accelerator Research Organization, Tsukuba, Japan, one of the Institute of Particle and Nuclear Studies (IPNS) research groups is studying about muon. Their focuses are whether to find rare muon decay processes or to make a more precise measurement of some muon fundamental characteristics such as the magnetic or electric dipole moment. To do so, they proposed several experiments and some of them are COMET (COherent Muon to Electron Transition) experiment which investigates the existence of a muon to electron ($\mu \rightarrow e$) transition process [1] and Muon $g-2$ /EDM experiment which provides a more precise measurement of a muon anomalous magnetic moment and the electric dipole moment [4].

2. COMET Experiment

The COMET experiment looks for a rare and yet unknown phenomenon called the Lepton Flavor Violation (LFV). Since the LFV in the charged lepton sector (sometimes called the Charged Lepton Flavor Violation or CLFV) is not allowed by the Standard Model (SM) [5], COMET experiment searches for the Beyond Standard Model (BSM) phenomenon or New Physics (NP)

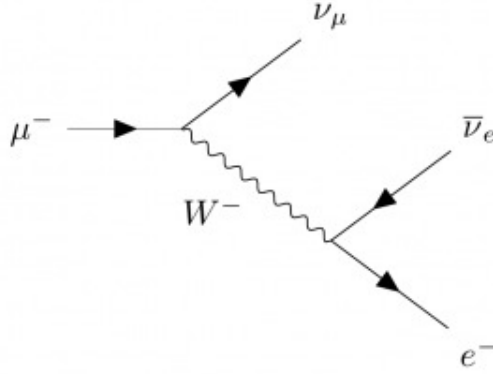

Figure 1. Feynman diagram illustration of a muon decay process in the Standard Model (SM) of particle physics.

since it predicts the existence of a muon to electron ($\mu \rightarrow e$) transition without involving neutrinos. The COMET Phase-I experiment will be held at J-PARC (Japan Proton Accelerator Research Complex) in Tokai and reaches sensitivity of 10^{-15} and even greater in Phase-II at 10^{-18} sensitivity [3].

In this experiment, protons are accelerated to 8 GeV energy from J-PARC main ring. After the beam hits a graphite target, pions will be produced and later decay into muons [1]. An aluminum target catch the muons and when they hit the target, muonic atoms are formed, kicked out the electron in 1s ground state with a sufficiently high energy [3]. The reaction process can be described by

$$\mu^- + N(A, Z) \rightarrow e^- + N(A, Z). \quad (1)$$

Since the rest energy of an electron is very small (0.511 MeV) compared to a muon, the electron from a $\mu \rightarrow e$ process should have a high kinetic energy (around 105 MeV) [1]. COMET experiment looks for this high energy electron.

2.1. Photon Detector and The Multi-Pixel Photon Counter (MPPC)

To detect the presence of high energy electrons as a result of the $\mu \rightarrow e$ transition process, COMET experiment uses an LYSO (Lithium-Yttrium Oxyorthosilicate) crystal as a scintillating material since it has a fast scintillation process which is better than an NaI or CsI crystal [1]. Fast scintillation process is important since the lifetime of a muon is short. An electron can excite an atom in the LYSO crystal and the atom will produce light when it returns to the ground state. Light from the scintillating materials then must be detected by photon detectors as a signal. Photomultiplier tube (PMT) is one of the most common photon detectors so far, but it is not really effective when it is placed inside a magnetic field since the electron path can be disturbed. Hence, new photon detectors must be considered.

Another detector technology is the Silicon photodetector or the photodiodes (Si PN) [2]. When a photon entering the photodiode has enough energy, it can disturb an equilibrium inside the Si PN and resulting a net current (photoelectric effect). This is a simple explanation of the operation principles of a photodiode. However, these photodiodes operate at a gain of 1, i.e. when 1 photon hits the photodiode, 1 electron is emitted. To make a photodetector with a gain more than 1, we have to consider silicon photodetectors with internal gain mechanism, such as the avalanche photodiode (APD).

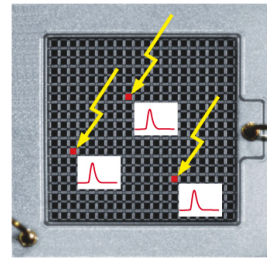
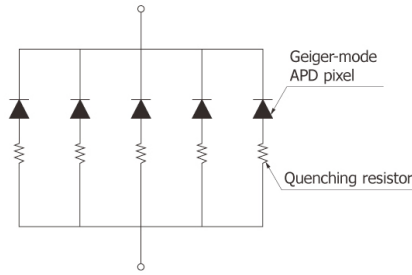

KAPDC0029EA



Figure 2. The structure of a single MPPC (top left), an illustration of how the MPPC counts an incoming photon as a signal (top right) (*source: HAMAMATSU website*), and a S13360-6050CS MPPC (bottom mid).

APDs can reach a high level of avalanche gain on the order of 10^5 to 10^6 which makes APD an interesting device to applications with low light levels. When detecting a light signal, there is a recharge process or recovery time for an APD to detect another light signal. During the recovery time period of avalanche multiplication, an APD is unable to detect a photoelectric event [2]. In order to overcome this problem, another silicon photodetector must again be considered and in this time, we will examine the multi-pixel photon counter (MPPC).

Also known as silicon photomultiplier or Si PM, the MPPC is a solid state photodetector which comprised of a high-density matrix of APD. Each pixel of APD enables a single photon detection with a high internal gain. In this work, we use a S13360-6050CS MPPC as shown in Figure 2 (bottom mid). This means the MPPC has 6×6 mm dimension and each pixel has a size of $50 \mu\text{m}$ [6]. To observe signal pulses created by the MPPC when detecting photons, we arrange a circuit system as shown in Figure 3. We cover up the circuit by a black MPPC box and two black sheets to make sure there are no lights coming from the outside and the only photons possible to enter the MPPC is one from the LED. We also attach a Pt100 thermoresistor to the circuit to keep an eye with the circuit's temperature since MPPC measurements are quite depends on the temperature. We attached a resistor parallel with the LED to prevent a sudden current flow that might broke the LED.

By applying a high voltage (around $56 - 59$ V) into the circuit, we can observe a triangle-shaped signal in the oscilloscope even before we inject a voltage pulse to the LED as shown in Figure 4 for the averaged signal. Notice that when applying high voltage to the MPPC, make sure that the whole circuit has been covered and no light from the outside entering the device. Otherwise, the MPPC may be broken due to a sudden huge avalanche process. Since we are looking for a low photoelectric event, the voltage pulse injected to the LED must be very narrow and in this work, we use a 70.00 ns width pulse with 1.500 Volt amplitude. Here we use the

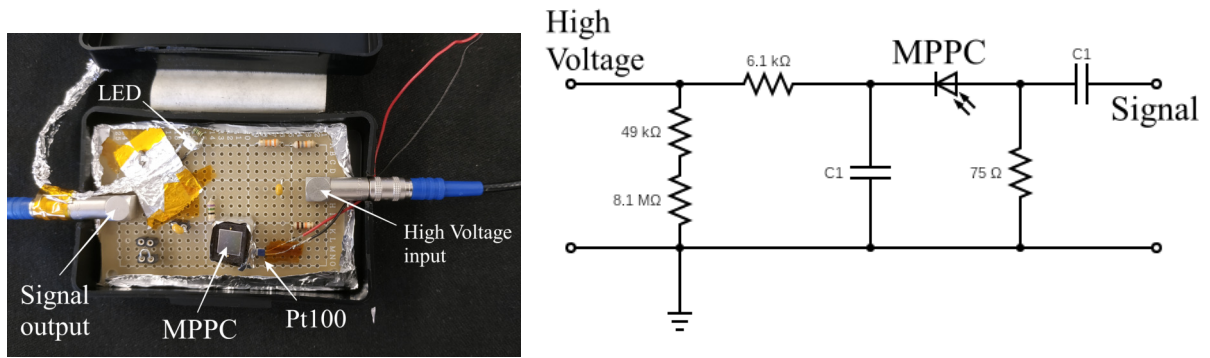

Figure 3. Circuit for the MPPC.

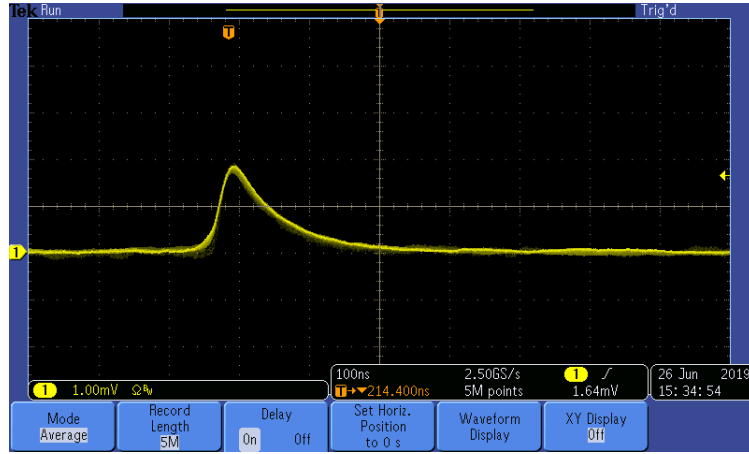

Figure 4. Observed signal with 58 V high voltage before injecting the pulse (averaged).

Tektronix AFC3102 function generator, TEXIO DC power supply, and Tektronix DPO 3034 Oscilloscope to make the voltage pulse for the LED, develop a high voltage source, and measure the signal, respectively as shown in Figure 5.

After we apply the voltage pulse to the LED, we will observe a signal as shown in Figure 6 and we can measure the voltage differences between two photoelectric events (v_I). The signals are violently fluctuating since the number of photons detected obeys some kind of distribution functions. When there are many photons entering MPPC, the distribution should be Gaussian but when only a few photons detected it become a Poisson distribution. This makes measuring peak differences accurately can be difficult. To make the measurement more precise, we repeat the same task for 10 times and each time we let the signals fluctuate for 10 seconds before we stop the oscilloscope display again. Then, we calculate the average value for every high voltage variations ranging from 56 V to 59 V by increasing 0.5 V each time. We also measure the signal time width (Δt) and the circuit's temperature for every high voltage variations. The results is shown in Table 1.

To make a conversion from peak differences into gain, we need to consider the total charge generated by the MPPC. As we mentioned before, in an Si PN, only 1 electron is emitted per 1 photon detection. Hence, MPPD gain can be calculated from

$$G = \frac{\text{Total charge generated by MPPC per 1 photon detection}}{1.602 \times 10^{-19}}. \quad (2)$$

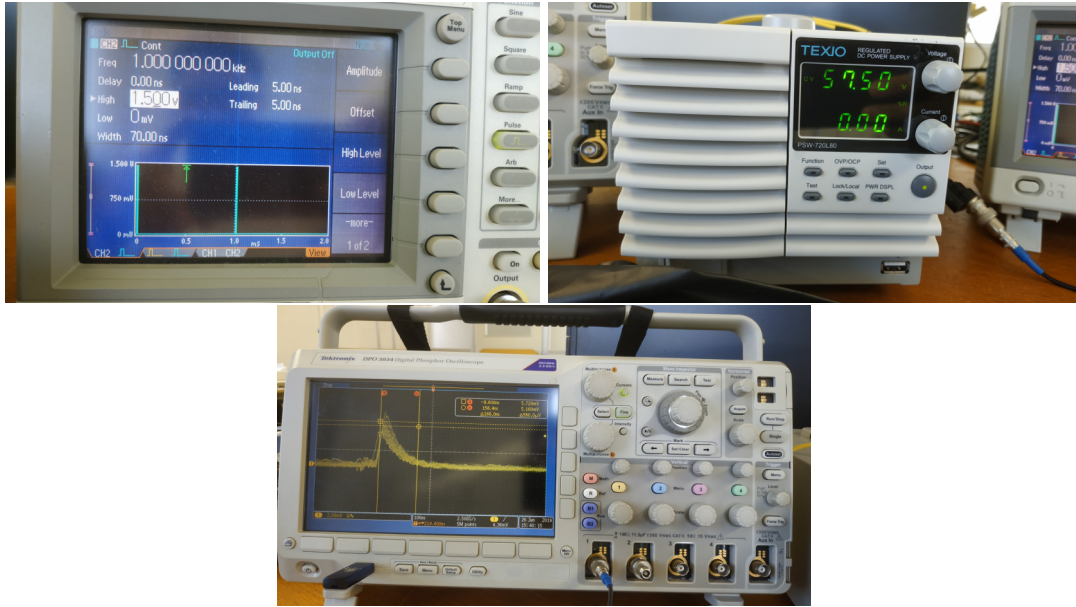

Figure 5. Tektronix AFG 3102 Function Generator (top left), TEXIO DC Power Supply (top right), and Tektronix DPO 3034 Oscilloscope (bottom mid).

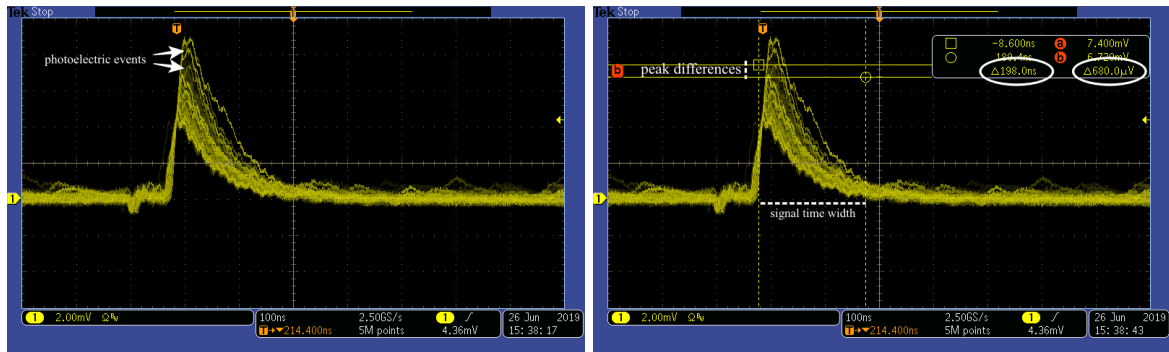

Figure 6. Observed signal with 58 V high voltage after injecting a pulse with 1.500 V amplitude and 70.00 ns width.

However, to calculate the total charge, we need to perform an integration for the signal. Exact computation can be very difficult. Hence, we use a rough approximation by considering that the signal is shaped like a triangle. Since the impedance of the circuit is set to 50 Ω , the gain becomes

$$G = \frac{\left(\frac{v_I}{50} \times \Delta t\right) \times \frac{1}{2}}{1.602 \times 10^{-19}}. \quad (3)$$

With the equation above, we can estimate the MPPC gain. We summarize them in Table 2 and make a graphical plot in Figure 7. From those we can see that the MPPC gain is in order of 10^6 when the temperature fluctuates between 26.5 to 27 $^{\circ}\text{C}$. It also has a linear relation with the high voltage applied to the MPPC circuit. This shows one of the fundamental characteristics of the MPPC [2].

Table 1. Table showing the peak differences (v_I), signal time width (Δt), and temperature for every high voltage (H.V.) variations. Here the LED voltage pulse is 1.500 V in amplitude and 70.00 ns in width.

H.V. (V)	v_I (mV)	Δt (ns)	Temp. ($^{\circ}\text{C}$)
56	0.576	154	26.51
56.5	0.584	161	27.01
57	0.696	174	27.01
57.5	0.734	179	26.25
58	0.772	180	26.76
58.5	0.763	193	26.76
59	0.972	194	26.51

Table 2. Table showing the MPPC gain (G) for every high voltage (H.V.) variations.

H.V. (V)	Gain (G)
56	5537078.652
56.5	5869163.546
57	7559550.562
57.5	8201373.283
58	8674157.303
58.5	9192197.253
59	11770786.52

2.2. LYSO Crystal as the Scintillation Material

LYSO ($\text{Lu}_{1.8}\text{Y}_{.2}\text{SiO}_5:\text{Ce}$) or Lutetium-Yttrium Oxyorthosilicate is a scintillation crystal that has many advantages compared to other materials. It has a high density (7.1 g/cm^3), very fast decay time (35 ns) compared to the muon lifetime, and is non-hygroscopic (having little tendency to absorb moisture). The output of a peak wavelength emission is well matched with the silicon photomultipliers or the MPPC, with 420 nm output wavelength [7]. Hence, LYSO crystal is a good material choice for the detector in COMET (or other high energy physics) experiment(s).

As a Lutetium-based scintillator, the LYSO crystal contains a naturally radioactive isotope ^{176}Lu (beta emitter). The decay results 3 different photon emission of 302, 202, and 88 keV energy and sometimes they are emitted together to form a higher energy emission. Consequently, when we attach the LYSO crystal to the MPPC and applying a high voltage, we can see some signals detected by the photodetector even when we use no source or LED light. We are expecting to see a $+88 + 202 + 307 = 597 \text{ keV}$ energy emission at most from the radioactive process.

For the next work, we want to see the natural behavior of the LYSO crystal by attaching it to our previous MPPC circuit and analyze the signal. For doing that, we made a new setup so we can attach the LYSO crystal to the MPPC which can be seen in Figure 8. We did not attach the LYSO crystal directly to the MPPC since we don't want to disturb radiation from LYSO since the crystal has a higher refraction index than air. Hence, we put a silicon medium with similar refraction index in between. From now, we attach the oscilloscope to a data acquisition system (DAQ) to analyze the signal at 58.5 V high voltage.

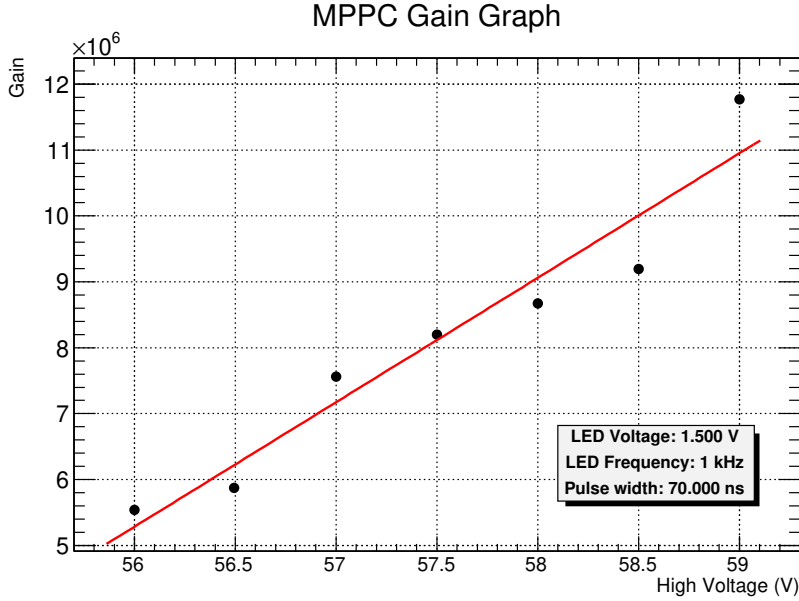

Figure 7. Measured S13360-6050CD MPPC Gain vs High Voltage.

In this work, we took two separated data with different thresholds. The first one is to aim signals coming from the natural radioactive behavior and the other is to detect the presence of cosmic ray muons. Signals from natural radioactive behavior are quite small compared to the first threshold at -72 mV therefore we have to set a $\times 4$ multiplication when the other comes from cosmic ray muons have much larger energy, we only set a $\times 1$ multiplication for the second threshold at -170 mV. Since the thresholds are set to be negative, we also invert the signals coming from our setup. We took the data with 1 GHz sampling which means that $1 \mu\text{s}$ data was written and since the DAQ system has 1024 entries, every points are $1 \mu\text{s}/1024 \approx 1$ ns in resolution. The peak-to-peak signal limit for the DAQ system is 1 V. Some of our data exceeds the peak-to-peak limit, indicating that some of the cosmic ray muons pass through a very long path inside the LYSO. But those cases are negligible since it will be very rare (approximately 1 of 1000 data).

2.2.1. Detection of the LYSO Natural Radioactivity To detect the LYSO natural radioactive process, we set the threshold to -72 mV. As mentioned before, since the signal is much smaller than the threshold, we have to set a $\times 4$ amplification and invert the signal. This does not affect any measurement since we can easily receive back the original data after calculation. We took 50000 entries and each entry is coming every time the signal surpasses threshold level. Using the DAQ system, we can set the bunch number to 10000 which means we take 10000 data for each bunch. Hence, we have to wait for the data taking process until it reaches 5 bunches. The DAQ system gives us 5 data and we can decode it to create 5 root files.

The next process is the data analysis. We want to calculate every charge generated by the MPPC for every entry. To do so, we have to re-invert the signal and do the integration by adding all of the voltage value for every point in the time axis from 0 to 1024. That process gives us 1 entry. After that, we do the same thing for the other 49999 entries. We create a histogram named "CC" and fill it with all of the entries to see the charge histogram. By using proper calculations, we can recover corresponding photoelectric events value. We also consider the 30% quantum efficiency of the MPPC to get the number of photon emitted [6]. We use the

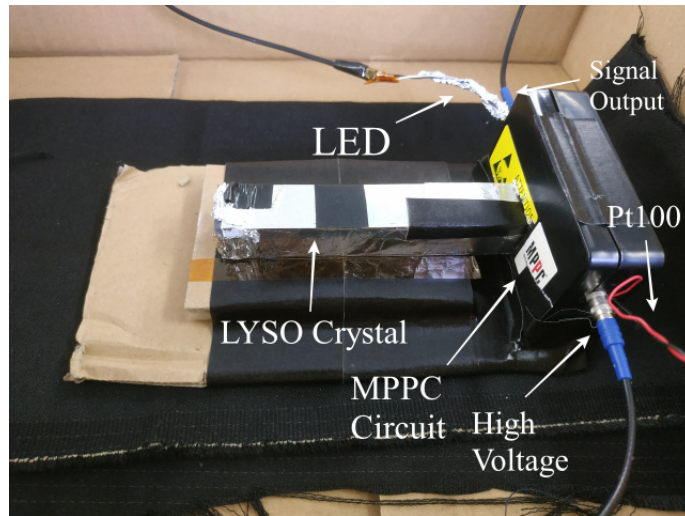

Figure 8. The new setup for analyzing the LYSO's natural characteristic.

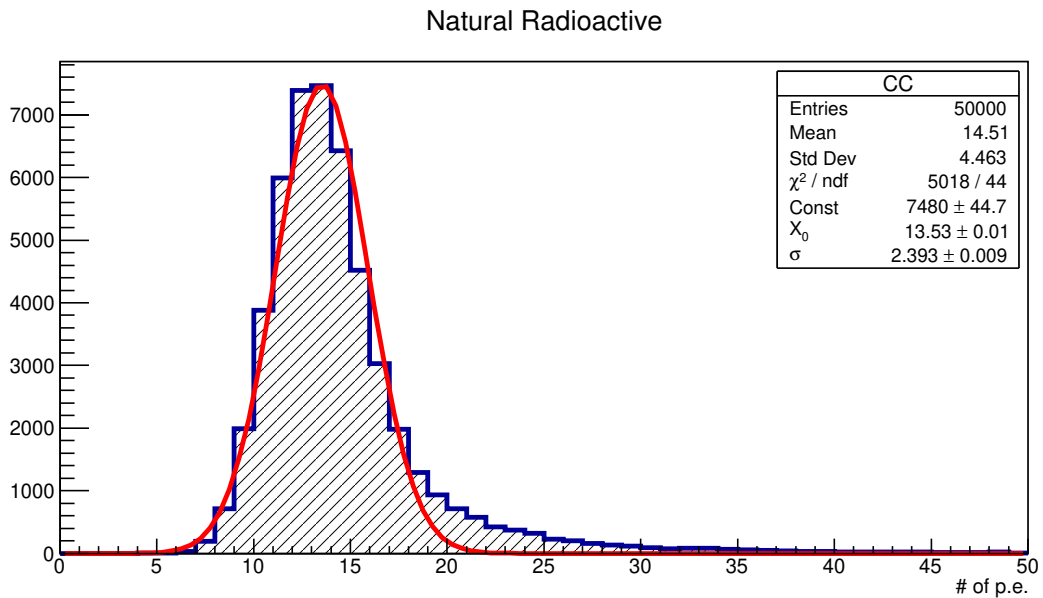

Figure 9. The new setup for analyzing the LYSO's natural characteristic.

previous MPPC Gain for a 58.5V high voltage which is $G = 10^7$ according to the linear fit in Figure 6. The result can be seen in Fig. 9 with a Gaussian function fit. According to the fit, # of p.e. (photon emitted) corresponds to the 597 keV emission is around 13 p.e. Hence, 1 p.e. corresponds to 45.62 keV or we can approximate it to 0.045 MeV. Here we could not detect the lower energy emissions such as the 302, 202, and 88 keV emission probably because we did not use lower threshold.

Cosmic Ray Muon

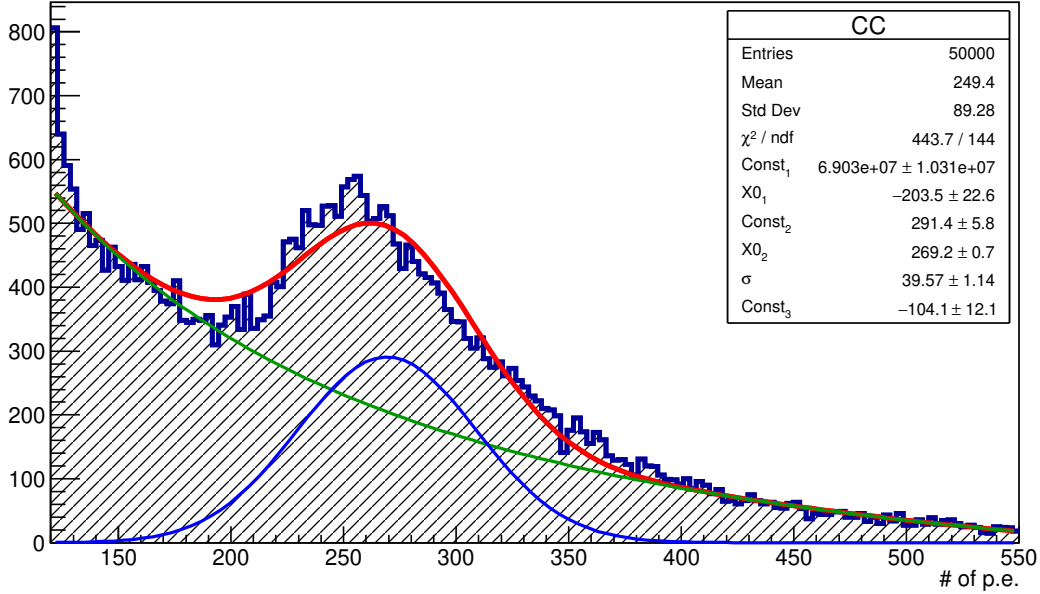

Figure 10. The new setup for analyzing the LYSO's natural characteristic.

2.2.2. Detection of Cosmic Ray Muons High energy radiations coming either from the sun or even outside the solar system are called the cosmic rays. Somehow, those particles can enter our scintillator detector and emerge a signal. Charged and uncharged particles lose energy while passing through materials. The stopping power of the material is equal to the loss of energy E per unit path length, x :

$$S(E) = -\frac{dE}{dx}. \quad (4)$$

The stopping power decreases approximately like $1/v^2$ with increasing particle velocity, and after it reaches minimum, it increases again. Particles having mean energy loss rate in the lowest point called the minimum ionizing particle (MIP). Relativistic particles such as cosmic ray muons are MIP with stopping power at around $2 \text{ MeV}\cdot\text{cm}^2/\text{g}$ [8].

We can calculate the photon energy emerged by a cosmic ray muon passing the scintillating material by considering the most probable path length passed by the particle as the height of LYSO crystal, 2 cm, and considering that the LYSO density is 7.1 g/cm^3 . Hence, the most probable photon energy from cosmic ray muon detected is approximately $2 \times 2 \times 7.1 = 28.4 \text{ MeV}$. From Fig. 9 we can see that the peak is at 269 p.e. Therefore, the peak corresponds to 12.1 MeV. This gives us a difference with a factor of 2. Here is our fitting function for the cosmic ray muon histogram. The green, red, and blue line represents $1/x^2$, Gaussian, and summed fit function, respectively.

$$\text{Const}_1 \times \frac{1}{(X - X0_1)^2} + \text{Const}_2 \times \exp(-(X - X0_2)^2/2\sigma^2) + \text{Const}_3. \quad (5)$$

In order to understand the difference completely, we have to make a simulation. Unfortunately, we don't have enough time to do that. Hence, we propose some hypotheses to answer the problem. When cosmic-ray muons pass through the LYSO crystal in a perpendicular direction, it will emit gamma-ray along a straight path. On the other hands, radiations from

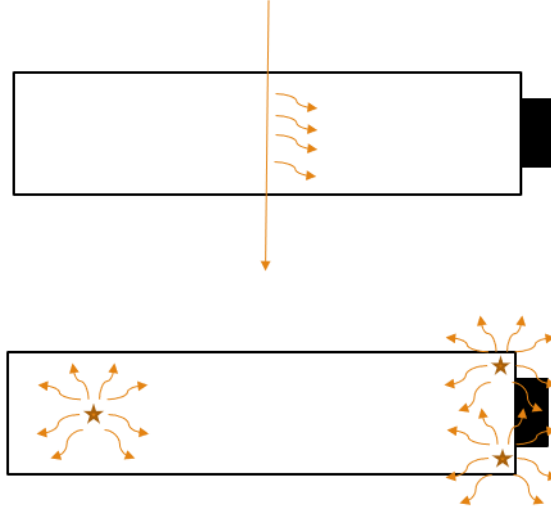

Figure 11. The new setup for analyzing the LYSO's natural characteristic.

natural radioactive processes are coming from a point and when it come from a location near the MPPC, detected radiations are not uniform (see Fig. 11). We also have to consider that the size of the MPPC is smaller than the LYSO face. Another possibility is radiation loss from total internal reflection that happens inside the LYSO crystal.

3. Muon $g-2$ /EDM Experiment

The muon $g-2$ /EDM experiment in J-PARC is a new approach to measure the muon anomalous magnetic moment $a_\mu = (g-2)/2$ and the muon electric dipole moment (EDM) d_μ simultaneously. Standard Model (SM) theoretical prediction for this measurement gives [4]

$$a_\mu(SM) = (11659182.3 \pm 0.1 \pm 3.4 \pm 2.6) \times 10^{-10}, \quad (6)$$

where the uncertainties are from electroweak, leading order hadronic, and even higher order hadronic contributions, respectively.

Even though SM is such a successful theory to explain particle physics to that order, new experimental results give more than 3σ discrepancy compared to the theoretical prediction. According to [9,10], the recent experimental value for a_μ is

$$a_\mu(exp) = (11659209.1 \pm 5.4 \pm 3.3) \times 10^{-10}, \quad (7)$$

where the errors are statistical and systematic uncertainties, respectively. We can see the difference between SM prediction and the experimental value as

$$\Delta a_\mu = a_\mu(exp) - a_\mu(SM) = (26.8 \pm 7.6) \times 10^{-10}, \quad (8)$$

that gives 3.5σ deviation. This result may open the path to the undiscovered physics beyond the SM.

Muon $g-2$ /EDM experiment in J-PARC wants to measure a_μ and d_μ with a different technique.

4. Summary

In this article, we present the detection of cosmic-ray muons coming from every direction using the LYSO crystal and MPPC as the scintillating material and photon detector, respectively. We found that the detected cosmic-ray muons energy deviates our prediction from calculation that considering the cosmic-ray muons are minimum ionizing particles (MIP) by the factor of two. The error may come from inaccurate MPPC gain measurement, or other factors such as not considering different radiation paths and a size difference between the LYSO area and the MPPC area. This detection system is one of many parts in the main COMET (COherent Muon to Electron Transition) experiment.

Acknowledgements

Authors would like to thanks KEK SOKENDAI Office for financially supporting most of the work done in KEK Tsukuba Campus with the KEK SOKENDAI Summer Student Program. We also would like to thanks Prof. Satoshi Mihara, Dr. Kazuki Ueno, and Dr. Rie Murayama for helping us in the COMET project along with Dr. Tsutomu Mibe and Dr. Daisuke Nomura for the Muon g-2/EDM project. Also many thanks to other colleagues involved in the KEK SOKENDAI Summer Student Program and students in the muon g-2/EDM group.

References

- 1 G. Adamov et. al. (The COMET Collaboration). 2018. *COMET Phase-I Technical Design Report: Part 1*. arXiv:1812.09018 [physics.ins-det].
- 2 A. Ghassemi, K. Sato, K. Kobayashi. 2017. MPPC Technical Note. HAMAMATSU: Japan.
- 3 R. Akhmetshin et. al. 2012. *Letter of Intent for Phase-I of the COMET Experiment at J-PARC*. The COMET Collaboration.
- 4 M. Abe, et. al. 2015. *A New Approach for Measuring the Muon Anomalous Magnetic Moment and Electric Dipole Moment*. *Prog. Theor. Exp. Phys.* **2015**, 0000.
- 5 L. Calibbi, G. Signorelli. 2017. *Charged Lepton Flavour Violation: An Experimental and Theoretical Introduction*. arXiv:1709.00294 [hep-ph].
- 6 HAMAMATSU PHOTONICS K.K., Solid State Division. 2016. *MPPC (Multi-Pixel Photon Counter) arrays S13361-6050 series Datasheet*. HAMAMATSU Japan.
- 7 LYSO Scintillation Material Datasheet. Saint-Goban Crystals. 2004-2017 Saint-Goban Ceramics & Plastics, Inc.
- 8 D. E. Groom, N. V. Mokhov, and S. I. Striganov. *Muon Stopping Power and Range Tables 10 MeV-100TeV*. Atomic Data and Nuclear Data Tables, Vol. 76, **2**, July 2001.
- 9 M. Tadamashi, et. al. [Particle Data Group], Phys. Ref. D **98**, 030001 (2018).
- 10 G. W. Bennett, et. al. [Muon g-2 Collaboration], Phys. Rev. D **73**, 072003 (2006).